

Fire Alarm Control Panel MS-9200UD/MS-9200UDE

IMPORTANT! The SLC Manual Document #51309 must be referenced in addition to this manual when installing or servicing the Fire Alarm Control Panel.

Fire Alarm System Limitations

An automatic fire alarm system—typically made up of smoke detectors, heat detectors, manual pull stations, audible warning devices, and a fire alarm control with remote notification capability—can provide early warning of a developing fire. Such a system, however, does not assure protection against property damage or loss of life resulting from a fire.

The Manufacturer recommends that smoke and/or heat detectors be located throughout a protected premise following the recommendations of the current edition of the National Fire Protection Association Standard 72 (NFPA 72), manufacturer's recommendations, State and local codes, and the recommendations contained in the Guide for Proper Use of System Smoke Detectors, which is made available at no charge to all installing dealers. A study by the Federal Emergency Management Agency (an agency of the United States government) indicated that smoke detectors may not go off in as many as 35% of all fires. While fire alarm systems are designed to provide early warning against fire, they do not guarantee warning or protection against fire. A fire alarm system may not provide timely or adequate warning, or simply may not function, for a variety of reasons:

Smoke detectors may not sense fire where smoke cannot reach the detectors such as in chimneys, in or behind walls, on roofs, or on the other side of closed doors. Smoke detectors also may not sense a fire on another level or floor of a building. A second-floor detector, for example, may not sense a first-floor or basement fire.

Particles of combustion or "smoke" from a developing fire may not reach the sensing chambers of smoke detectors because:

- Barriers such as closed or partially closed doors, walls, or chimneys may inhibit particle or smoke flow.
- Smoke particles may become "cold," stratify, and not reach the ceiling or upper walls where detectors are located.
- Smoke particles may be blown away from detectors by air outlets.
- Smoke particles may be drawn into air returns before reaching the detector.

The amount of "smoke" present may be insufficient to alarm smoke detectors. Smoke detectors are designed to alarm at various levels of smoke density. If such density levels are not created by a developing fire at the location of detectors, the detectors will not go into alarm.

Smoke detectors, even when working properly, have sensing limitations. Detectors that have photoelectronic sensing chambers tend to detect smoldering fires better than flaming fires, which have little visible smoke. Detectors that have ionizing-type sensing chambers tend to detect fast-flaming fires better than smoldering fires. Because fires develop in different ways and are often unpredictable in their growth, neither type of detector is necessarily best and a given type of detector may not provide adequate warning of a fire.

Smoke detectors cannot be expected to provide adequate warning of fires caused by arson, children playing with matches (especially in bedrooms), smoking in bed, and violent explosions (caused by escaping gas, improper storage of flammable materials, etc.).

While a fire alarm system may lower insurance rates, it is not a substitute for fire insurance!

Heat detectors do not sense particles of combustion and alarm only when heat on their sensors increases at a predetermined rate or reaches a predetermined level. Rate-of-rise heat detectors may be subject to reduced sensitivity over time. For this reason, the rate-of-rise feature of each detector should be tested at least once per year by a qualified fire protection specialist. *Heat detectors are designed to protect property, not life.*

IMPORTANT! Smoke detectors must be installed in the same room as the control panel and in rooms used by the system for the connection of alarm transmission wiring, communications, signaling, and/or power. If detectors are not so located, a developing fire may damage the alarm system, crippling its ability to report a fire.

Audible warning devices such as bells may not alert people if these devices are located on the other side of closed or partly open doors or are located on another floor of a building. Any warning device may fail to alert people with a disability or those who have recently consumed drugs, alcohol or medication. Please note that:

- Strobes can, under certain circumstances, cause seizures in people with conditions such as epilepsy.
- Studies have shown that certain people, even when they hear a fire alarm signal, do not respond or comprehend the meaning of the signal. It is the property owner's responsibility to conduct fire drills and other training exercise to make people aware of fire alarm signals and instruct them on the proper reaction to alarm signals.
- In rare instances, the sounding of a warning device can cause temporary or permanent hearing loss.

A fire alarm system will not operate without any electrical power. If AC power fails, the system will operate from standby batteries only for a specified time and only if the batteries have been properly maintained and replaced regularly.

Equipment used in the system may not be technically compatible with the control. It is essential to use only equipment listed for service with your control panel.

Telephone lines needed to transmit alarm signals from a premise to a central monitoring station may be out of service or temporarily disabled. For added protection against telephone line failure, backup radio transmission systems are recommended.

The most common cause of fire alarm malfunction is inadequate maintenance. To keep the entire fire alarm system in excellent working order, ongoing maintenance is required per the manufacturer's recommendations, and UL and NFPA standards. At a minimum, the requirements of Chapter 7 of NFPA 72 shall be followed. Environments with large amounts of dust, dirt or high air velocity require more frequent maintenance. A maintenance agreement should be arranged through the local manufacturer's representative. Maintenance should be scheduled monthly or as required by National and/or local fire codes and should be performed by authorized professional fire alarm installers only. Adequate written records of all inspections should be kept.

Installation Precautions

WARNING - Several different sources of power can be connected to the fire alarm control panel. Disconnect all sources of power before servicing. Control unit and associated equipment may be damaged by removing and/or inserting cards, modules, or interconnecting cables while the unit is energized. Do not attempt to install, service, or operate this unit until this manual is read and understood.

CAUTION - *System Reacceptance Test after Software Changes.* To ensure proper system operation, this product must be tested in accordance with NFPA 72 Chapter 7 after any programming operation or change in site-specific software. Reacceptance testing is required after any change, addition or deletion of system components, or after any modification, repair or adjustment to system hardware or wiring.

All components, circuits, system operations, or software functions known to be affected by a change must be 100% tested. In addition, to ensure that other operations are not inadvertently affected, at least 10% of initiating devices that are not directly affected by the change, up to a maximum of 50 devices, must also be tested and proper system operation verified.

This system meets NFPA requirements for operation at 0-49° C/32-120° F and at a relative humidity of 85% RH (non-condensing) at 30° C/86° F. However, the useful life of the system's standby batteries and the electronic components may be adversely affected by extreme temperature ranges and humidity. Therefore, it is recommended that this system and all peripherals be installed in an environment with a nominal room temperature of 15-27° C/60-80° F.

Verify that wire sizes are adequate for all initiating and indicating device loops. Most devices cannot tolerate more than a 10% I.R. drop from the specified device voltage.

Adherence to the following will aid in problem-free installation with long-term reliability:

Like all solid state electronic devices, this system may operate erratically or can be damaged when subjected to lightning-induced transients. Although no system is completely immune from lightning transients and interferences, proper grounding will reduce susceptibility. *Overhead or outside aerial wiring is not recommended, due to an increased susceptibility to nearby lightning strikes.* Consult with the Technical Services Department if any problems are anticipated or encountered.

Disconnect AC power and batteries prior to removing or inserting circuit boards. Failure to do so can damage circuits.

Remove all electronic assemblies prior to any drilling, filing, reaming, or punching of the enclosure. When possible, make all cable entries from the sides or rear. Before making modifications, verify that they will not interfere with battery, transformer, and printed circuit board location.

Do not tighten screw terminals more than 9 in-lbs. Over-tightening may damage threads, resulting in reduced terminal contact pressure and difficulty with screw terminal removal.

Though designed to last many years, system components can fail at any time. This system contains static-sensitive components. Always ground yourself with a proper wrist strap before handling any circuits so that static charges are removed from the body. Use static-suppressive packaging to protect electronic assemblies removed from the unit.

Follow the instructions in the installation, operating, and programming manuals. These instructions must be followed to avoid damage to the control panel and associated equipment. FACP operation and reliability depend upon proper installation by authorized personnel.

FCC Warning

WARNING: This equipment generates, uses, and can radiate radio frequency energy and if not installed and used in accordance with the instruction manual, may cause interference to radio communications. It has been tested and found to comply with the limits for class A computing device pursuant to Subpart B of Part 15 of FCC Rules, which is designed to provide reasonable protection against such interference when operated in a commercial environment. Operation of this equipment in a residential area is likely to cause interference, in which case the user will be required to correct the interference at his own expense.

Canadian Requirements

This digital apparatus does not exceed the Class A limits for radiation noise emissions from digital apparatus set out in the Radio Interference Regulations of the Canadian Department of Communications.

Le présent appareil numérique n'émet pas de bruits radioélectriques dépassant les limites applicables aux appareils numériques de la classe A prescrites dans le Règlement sur le brouillage radioélectrique édicté par le ministère des Communications du Canada.

Notes

Table of Contents

SECTION 1: Product Description	12
1.1: Features and Options	12
1.2: Specifications	14
1.2.1: Current Availability	15
1.3: Controls and Indicators	16
1.4: Circuits	17
1.5: Digital Alarm Communicator/Transmitter	17
1.6: Components	18
1.6.1: Intelligent Addressable Detectors: Newer Series	18
1.6.2: Intelligent Addressable Modules: Newer Series	19
1.6.3: 300 Series Intelligent Addressable Devices	20
1.6.4: Addressable Device Accessories	20
1.7: Optional Modules	21
1.8: Accessories	21
1.8.1: PK-CD Programming Utility	21
1.8.2: Dress Panel	21
1.8.3: Battery Box	22
1.8.4: Battery Charger	22
1.8.4.1 CHG-75 Battery Charger	22
1.8.4.2 CHG-120F Battery Charger	22
1.8.5: Annunciators	23
1.9: Getting Started	24
1.10: Telephone Requirements and Warnings	25
1.10.1: Telephone Circuitry	25
1.10.2: Digital Communicator	25
1.10.3: Telephone Company Rights and Warnings	26
SECTION 2: Installation	27
2.1: Mounting Backbox	27
2.2: Mounting Transformer	28
2.3: Power	31
2.3.1: AC Power and Earth Ground Connection	31
2.3.2: Battery Power	31
2.3.3: DC Power Output Connection	31
2.4: Relays	32
2.5: Notification Appliance Circuits	32
2.5.1: Configuring NACs	33
2.5.2: Style Y (Class B) NAC Wiring	33
2.5.3: Style Z (Class A) NAC Wiring	34
2.6: Remote Synchronization Output	34
2.7: UL Power-limited Wiring Requirements	35
2.8: Digital Communicator	36
2.9: Optional Module Installation	37
2.9.1: 4XTMF Transmitter Module Installation	38
2.9.2: Printer/PC	40
2.9.3: Digital Communicator and Annunciators	41
2.9.3.1 ACM-8RF Relay Control Module	41
2.9.3.2 BRKT-9600 Universal Bracket Installation	41
2.9.3.3 ACM and AFM Series Annunciators	43
SECTION 3: Programming	44
3.1: Programming Data Entry	44
3.2: User Programming	45
3.3: Initial Power-up	46

Table of Contents

- 3.4: Programming Screens Description 46
- 3.5: Programming and Passwords 46
- 3.6: Master Programming Level 48
 - 3.6.1: Autoprogram 49
 - 3.6.2: Point Program 50
 - 3.6.2.1 Detector Programming 50
 - 3.6.2.1.1 Add Detector 50
 - 3.6.2.1.2 Delete Detector 51
 - 3.6.2.1.3 Edit Detector 51
 - 3.6.2.2 Module Programming 60
 - 3.6.2.2.1 Add Module 60
 - 3.6.2.2.2 Delete Module 61
 - 3.6.2.2.3 Edit Module Screen for Monitor Module 61
 - 3.6.2.2.4 Edit Module Screen for Control Modules 70
 - 3.6.3: Zone Setup 77
 - 3.6.3.1 Enable 77
 - 3.6.3.2 Disable 78
 - 3.6.3.3 Zone 97, 98 and 99 78
 - 3.6.3.4 Zones Installed 79
 - 3.6.3.5 Zones Enabled 79
 - 3.6.3.6 Zones Disabled 79
 - 3.6.3.7 Zone Type 80
 - 3.6.3.8 Zones Available 81
 - 3.6.4: Loop Setup 81
 - 3.6.4.1 Style 81
 - 3.6.4.2 Loop Protocol 81
 - 3.6.5: System Setup 82
 - 3.6.5.1 Trouble Reminder 83
 - 3.6.5.2 Banner 83
 - 3.6.5.3 Time-Date 84
 - 3.6.5.3.1 Time 84
 - 3.6.5.3.2 Date 85
 - 3.6.5.3.3 Clock Format 85
 - 3.6.5.3.4 Daylight Savings Time 85
 - 3.6.5.4 Timers 86
 - 3.6.5.4.1 PAS (Positive Alarm Sequence) Delay 86
 - 3.6.5.4.2 Pre-signal Delay 87
 - 3.6.5.4.3 Waterflow Delay 87
 - 3.6.5.4.4 AC Loss Delay 88
 - 3.6.5.5 NAC (Notification Appliance Circuit) 88
 - 3.6.5.5.1 Enabled 89
 - 3.6.5.5.2 Type 90
 - 3.6.5.5.3 Silenceable 90
 - 3.6.5.5.4 Auto Silence 91
 - 3.6.5.5.5 Coding (only for NACs not programmed as Sync Strobe Type) 91
 - 3.6.5.5.6 Zone 93
 - 3.6.5.5.7 Silence Inhibited 93
 - 3.6.5.5.8 Sync Type 93
 - 3.6.5.6 Relays 94
 - 3.6.5.7 Canadian Option 95
 - 3.6.5.8 Waterflow Silenceable 95
 - 3.6.6: Verify Loop 95
 - 3.6.7: History 96
 - 3.6.7.1 View Events 96
 - 3.6.7.2 Erase History 96
 - 3.6.8: Walktest 97

Table of Contents

3.6.9: Option Modules.....	98
3.6.9.1 Annunciators/UDACT	98
3.6.9.2 Onboard DACT	99
3.6.9.2.1 Onboard DACT Enable	99
3.6.9.2.2 Primary Phone	100
3.6.9.2.3 Secondary Phone	100
3.6.9.2.4 Service Terminal	101
3.6.9.2.5 Central Station	103
3.6.9.2.6 Trouble Call Limit (Dialer Runaway Prevention)	104
3.6.9.2.7 Manual Dial Mode	116
3.6.9.3 Printer/PC	117
3.6.10: Password Change	118
3.6.11: Clear Program	119
3.6.12: Program Check.....	120
3.7: Maintenance Programming Level.....	122
3.7.1: Disable Point	123
3.7.2: History.....	124
3.7.3: Program Check.....	125
3.7.4: Walktest.....	126
3.7.5: System.....	126
3.7.6: Zone Setup	128
SECTION 4: Operating Instructions	130
4.1: Panel Control Buttons	130
4.1.1: Acknowledge/Step	130
4.1.2: Alarm Silence.....	130
4.1.3: Drill/Hold 2 Sec	130
4.1.4: Reset.....	130
4.2: LED Indicators	131
4.3: Normal Operation.....	132
4.4: Trouble Operation	132
4.5: Alarm Operation.....	134
4.6: Supervisory Operation.....	135
4.7: Process Monitor Operation.....	136
4.8: Hazard/Tornado Condition Operation	136
4.9: Medical Alert Condition Operation.....	136
4.10: NAC Operation	136
4.11: Programmed Zone Operation	137
4.12: Disable/Enable Operation	137
4.13: Waterflow Circuits Operation	137
4.14: Detector Functions	137
4.15: Time Functions: Real-Time Clock	137
4.16: Synchronized NAC Operation	138
4.17: Coded Operation	138
4.18: Presignal.....	138
4.19: Positive Alarm Sequence	139
4.20: Special System Timers	140
4.20.1: Silence Inhibit Timer.....	140
4.20.2: Autosilence Timer.....	140
4.20.3: Trouble Reminder	140
4.20.4: Waterflow Retard Timer.....	140
4.20.5: Alarm Verification (None or One Minute).....	141
4.21: Walktest	141
4.22: Read Status	142
4.22.1: System Point	143

Table of Contents

4.22.2: Zones	144
4.22.3: Power.....	145
4.22.4: Trouble Reminder.....	146
4.22.5: Timers.....	146
4.22.6: NAC	147
4.22.7: Relays	147
4.22.8: Program Check.....	148
4.22.9: History.....	148
4.22.10: Annunciators	149
4.22.11: Phone Line.....	149
4.22.12: Central Station.....	150
4.22.13: Service Terminal.....	151
4.22.14: Printer/PC	151
4.22.15: Print	152
4.22.16: Time-Date.....	154
SECTION 5: Central Station Communications	155
5.1: Transmittal Priorities	158
SECTION 6: Remote Site Upload/Download	160
6.1: Downloading Program.....	160
6.1.1: Security Features	161
6.2: Downloading Initiated at a Service Terminal	163
6.3: Uploading Initiated at a Service Terminal	164
SECTION 7: Power Supply Calculations	165
7.1: Overview	165
7.2: Calculating the AC Branch Circuit.....	165
7.3: Calculating the System Current Draw.....	166
7.3.1: Overview	166
7.3.2: How to Use Table 7.3 on page 167 to Calculate System Current Draw	166
7.4: Calculating the Battery Size	168
7.4.1: NFPA Battery Requirements	168
7.4.2: Selecting and Locating Batteries.....	168
APPENDIX A: Software Zones	169
A.1: Correlations	169
APPENDIX B: Default Programming	175
APPENDIX C: NFPA Standard-Specific Requirements	176
APPENDIX D: Wire Requirements	180

It is imperative that the installer understand the requirements of the Authority Having Jurisdiction (AHJ) and be familiar with the standards set forth by the following regulatory agencies:

- Underwriters Laboratories Standards
- NFPA 72 National Fire Alarm Code

Before proceeding, the installer should be familiar with the following documents.



NFPA Standards

- NFPA 72 National Fire Alarm Code
- NFPA 70 National Electrical Code



Underwriters Laboratories Documents:

- UL 38 Manually Actuated Signaling Boxes
- UL 217 Smoke Detectors, Single and Multiple Station
- UL 228 Door Closers–Holders for Fire Protective Signaling Systems
- UL 268 Smoke Detectors for Fire Protective Signaling Systems
- UL 268A Smoke Detectors for Duct Applications
- UL 346 Waterflow Indicators for Fire Protective Signaling Systems
- UL 464 Audible Signaling Appliances
- UL 521 Heat Detectors for Fire Protective Signaling Systems
- UL 864 Standard for Control Units for Fire Protective Signaling Systems
- UL 1481 Power Supplies for Fire Protective Signaling Systems
- UL 1610 Central Station Burglar Alarm Units
- UL 1638 Visual Signaling Appliances
- UL 1971 Signaling Devices for Hearing Impaired

Other:

- EIA-232E Serial Interface Standard
- EIA-485 Serial Interface Standard
- NEC Article 250 Grounding
- NEC Article 300 Wiring Methods
- NEC Article 760 Fire Protective Signaling Systems
- Applicable Local and State Building Codes
- Requirements of the Local Authority Having Jurisdiction (LAHJ)

Fire•Lite Documents:

- | | |
|---------------------------------|-----------------|
| Fire•Lite Device Compatibility | Document #15384 |
| SLC Wiring Manual | Document #51309 |
| AFM-16ATF & AFM-32AF | Document #15970 |
| AFM-16AF Annunciator | Document #15210 |
| ACS Series Annunciators | Document #51480 |
| CHG-120F Battery Charger | Document #50888 |
| CHG-75 Battery Charger | Document #51315 |
| LDM Series Lamp Driver Modules | Document #50055 |
| LCD-80F Remote Fire Annunciator | Document #51338 |
| ACM-8RF Relay Control Module | Document #50362 |

Basic System Connections

Notification Appliance Circuits

NAC #1, #2, #3 & #4, Style Y (Class B) (Power Limited)
2.5 amps max. per circuit. JP6 configured for Class B using NACKEY card.
(See Style Z illustrated near right edge of board).



Remote Synchronization Output

24 VDC filtered, supervised and power-limited.
0.040 amps maximum, follows NAC1 control circuit.
Requires 4.7kOhm End-of-Line resistor.

DC Power Outputs (24 VDC)

Supervise with a power supervision relay A77-7168
Resettable Power - 24 VDC filtered, power-limited (0-500 amps maximum) to smoke detectors (IDC).
Supervision required.

Nonresettable or Resettable Power
Jumper selectable by JP4. 24 VDC filtered, power-limited (0-500 amps maximum)
Supervision required. (Nonresettable)
Power suitable for powering annunciators.
Resettable Power suitable for powering smoke detectors.

Configure TB1, Terminals 1 & 2
Resettable Power - Jumper pins 1 & 2
Nonresettable Power - jumper pins 2 & 3.

For more specific UL wiring information refer to page-35.



EIA-232C to Printer or personal computer
For EDP-listed equipment or personal computer with FACP Upload/Download Utility.
50 foot maximum within same room.

2 Programmable Relays & 1 Fixed Trouble Relay

Contact Ratings:
2.0 amps @ 30 VDC (resistive)
0.5 amps @ 30 VAC (resistive)
Contacts shown below in normal condition (AC power with no alarm, trouble or supervisory activity).

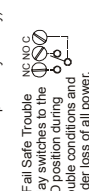

(*Factory default relay programming)

Supervisory Alarm

NO NC C

NO NC C

NO NC C

NO NC C

NO NC C

NO NC C

NO NC C

NO NC C

NO NC C

NO NC C

NO NC C

NO NC C

NO NC C

NO NC C

NO NC C

NO NC C

NO NC C

NO NC C

NO NC C

NO NC C

NO NC C

NO NC C

NO NC C

NO NC C

NO NC C

NO NC C

NO NC C

NO NC C

NO NC C

NO NC C

NO NC C

NO NC C

NO NC C

NO NC C

NO NC C

NO NC C

NO NC C

NO NC C

NO NC C

NO NC C

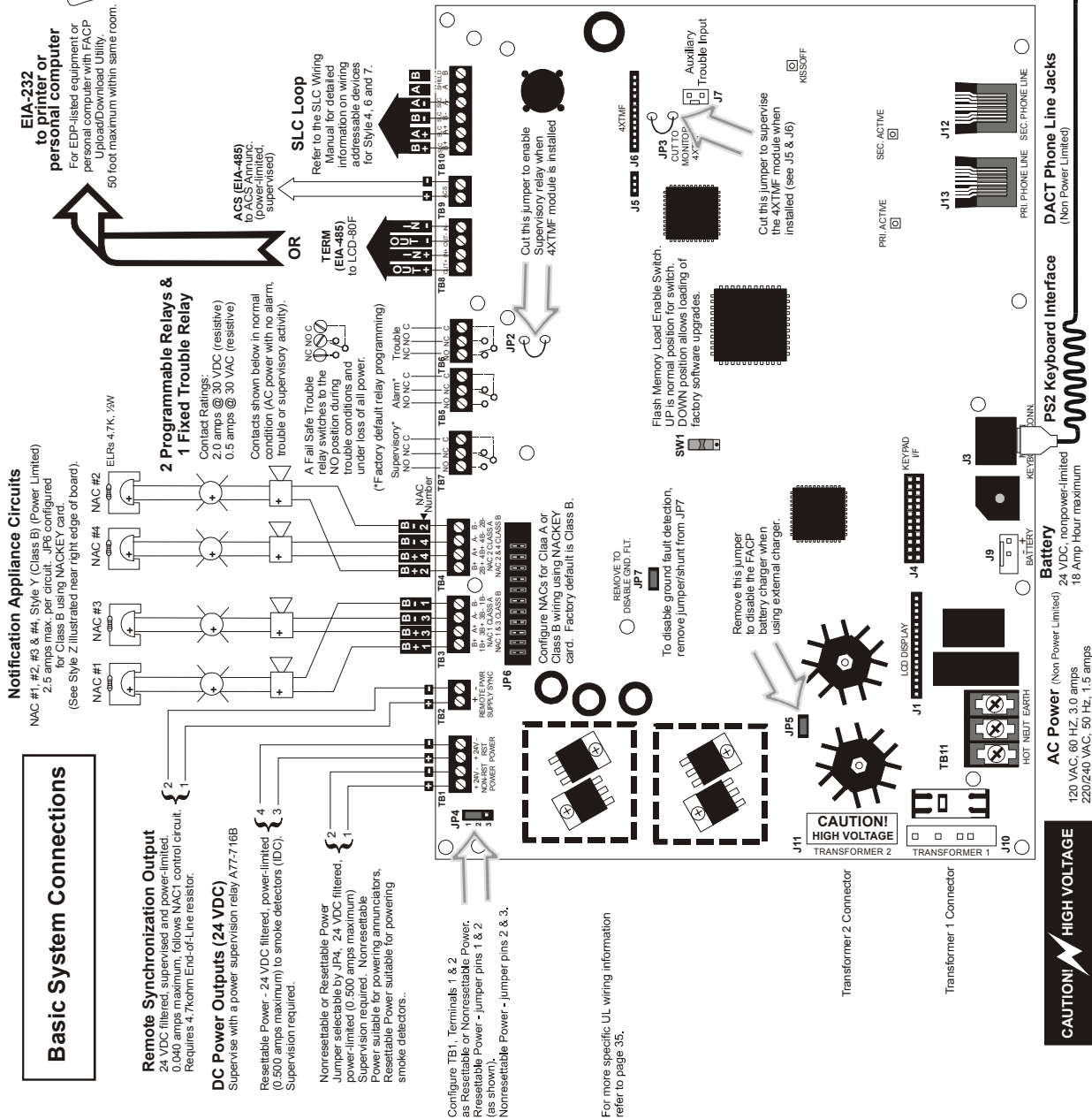

CAUTION! HIGH VOLTAGE

AC Power (Non Power Limited)
24 VDC, nonpower-limited
18 Amp Hour maximum

PS2 Keyboard Interface

DACT Phone Line Jacks
(Non Power Limited)

Notification Appliance Circuits

NAC #1 & #2
Style Z (Class A) (Power Limited)
2.5 amps max. per circuit.
JP6 configured for Class A using NACKEY card.

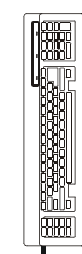
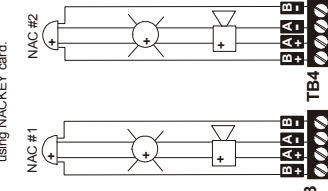

CAUTION! HIGH VOLTAGE

Transformer 2 Connector

Transformer 1 Connector

Remove this jumper to disable the FACP battery charger when using external charger.

To disable ground fault detection, remove jumper/shunt from JP7.

Cut this jumper to supervise the 4XTMIF module when installed (see J5 & J6)

Cut this jumper to enable Supervisory relay when 4XTMIF module is installed

Flash Memory Load Enable Switch. UP is normal position for switch. DOWN position allows loading of factory software upgrades.

JP3 CUT TO MONITOR 4X% Trouble Input

ACTIVE

REMOVE TO DISABLE GND-FIT JP7

REMOVE TO DISABLE GND-FIT JP7

REMOVE TO DISABLE GND-FIT JP7

REMOVE TO DISABLE GND-FIT JP7

REMOVE TO DISABLE GND-FIT JP7

REMOVE TO DISABLE GND-FIT JP7

REMOVE TO DISABLE GND-FIT JP7

REMOVE TO DISABLE GND-FIT JP7

REMOVE TO DISABLE GND-FIT JP7

REMOVE TO DISABLE GND-FIT JP7

REMOVE TO DISABLE GND-FIT JP7

REMOVE TO DISABLE GND-FIT JP7

REMOVE TO DISABLE GND-FIT JP7

REMOVE TO DISABLE GND-FIT JP7

REMOVE TO DISABLE GND-FIT JP7

REMOVE TO DISABLE GND-FIT JP7

REMOVE TO DISABLE GND-FIT JP7

REMOVE TO DISABLE GND-FIT JP7

REMOVE TO DISABLE GND-FIT JP7

REMOVE TO DISABLE GND-FIT JP7

REMOVE TO DISABLE GND-FIT JP7

REMOVE TO DISABLE GND-FIT JP7

REMOVE TO DISABLE GND-FIT JP7

REMOVE TO DISABLE GND-FIT JP7

REMOVE TO DISABLE GND-FIT JP7

REMOVE TO DISABLE GND-FIT JP7

REMOVE TO DISABLE GND-FIT JP7

REMOVE TO DISABLE GND-FIT JP7

REMOVE TO DISABLE GND-FIT JP7

REMOVE TO DISABLE GND-FIT JP7

REMOVE TO DISABLE GND-FIT JP7

Peripheral Devices and Their Documents:

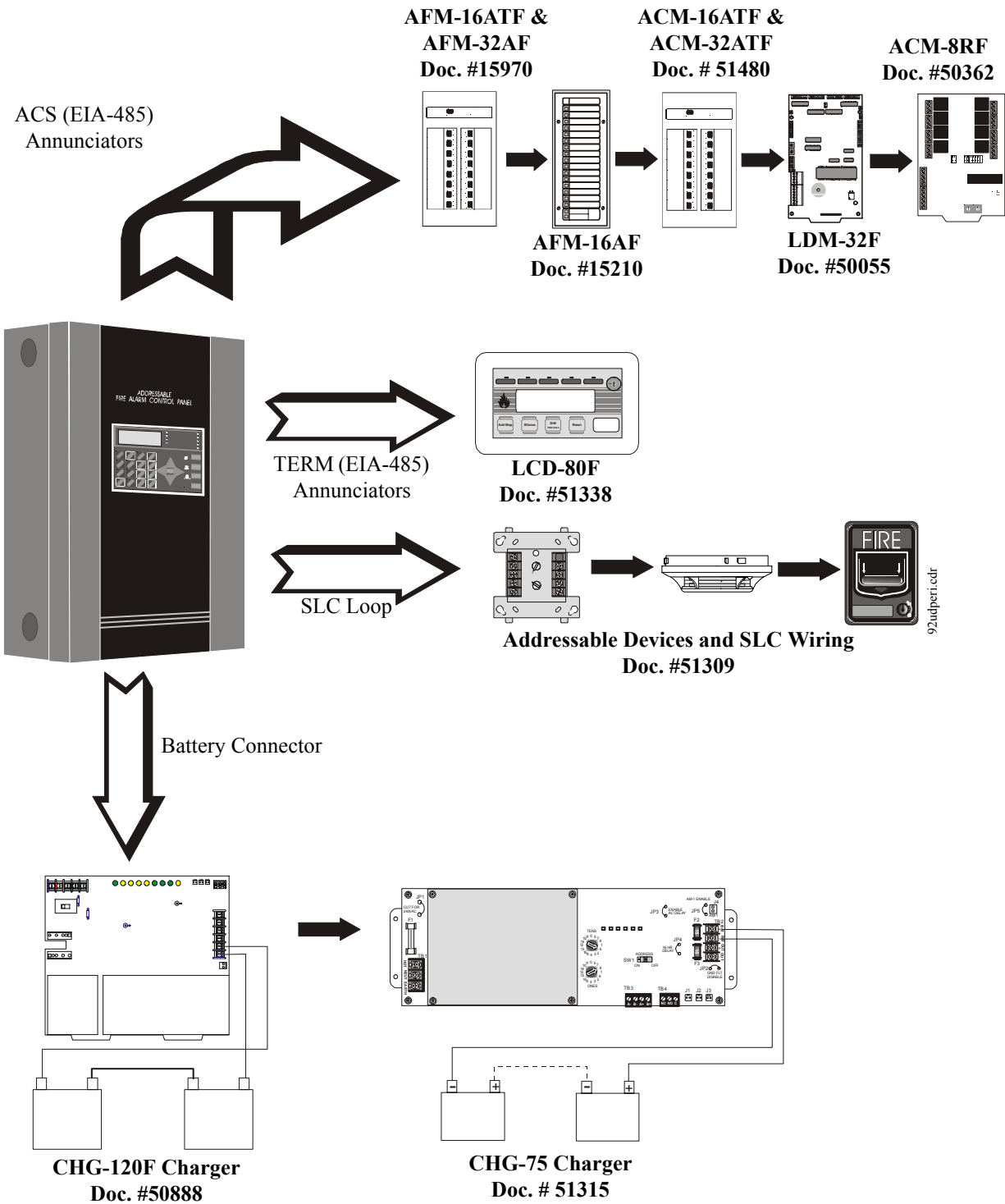

SECTION 1 Product Description

The Fire•Lite MS-9200UD is a combination FACP (Fire Alarm Control Panel) and DACT (Digital Alarm Communicator/Transmitter) all on one circuit board. This compact, cost effective, intelligent addressable control panel has an extensive list of powerful features. The combination of Fire•Lite's newer series devices and legacy 300 Series devices, along with the MS-9200UD FACP, offer the latest in fire protection technology. The power supply and all electronics are contained on a single circuit board housed in a metal cabinet, providing a complete fire control system for most applications. Optional modules, which plug into the main circuit board, are available for special functions. Available accessories include LED, graphic and LCD annunciators, reverse polarity/city box transmitter, local and remote upload/download software and remote power expansion.

The integral DACT transmits system status (alarms, troubles, AC loss, etc.) to a Central Station via the public switched telephone network. It also allows remote and local programming of the control panel using the PK-CD Upload/Download utility. In addition, the control panel may be programmed or interrogated off-site via the public switched telephone network. Any personal computer with Windows™ 95 or greater, and compatible modem with a speed of 14.4 kbps or faster and Fire•Lite Upload/Download software kit PK-CD, may serve as a Service Terminal. This allows download of the entire program or upload of the entire program, history file, walktest data, current status and system voltages.

Note: Unless otherwise specified, the term MS-9200UD is used in this manual to refer to both the MS-9200UD and the MS-9200UDE FACP's (Fire Alarm Control Panels).

Inventory

When the MS-9200UD shipment is received, check to make certain that all parts have been included in the shipment. The MS-9200UD shipment should consist of one of each of the following:

- ✓ main circuit board with display
- ✓ backbox with door
- ✓ plastic bag containing screws, cables, key, etc.
- ✓ manual

1.1 Features and Options

- Built-in DACT (Digital Alarm Communicator/Transmitter)
- Single addressable SLC loop which meets NFPA Style 4, 6 and 7 requirements
- 198 addressable device capacity (99 detectors and 99 control/relay/monitor modules)
- 99 software zones
- Onboard NACs (Notification Appliance Circuits) which can be configured as four Style Y (Class B) or two Style Z (Class A) circuits
- 3.0 amps total power for NACs and 24 VDC auxiliary power outputs expandable to 6.0 amps
- 3.6 amps total system power (includes battery charger) expandable to 6.6 amps
- Two programmable relay outputs and one fixed trouble relay
- Synchronization output for remote power supply applications
- Built-in Programmer
- Telephone Line Active LEDs
- Communication Confirmation (*Kissoff*) LED
- Touchtone/Rotary dialing
- Programmable Make/Break Ratio

- EIA-232 Printer/PC interface (variable baud rate)
- 80-character LCD display (backlit)
- Real-time clock/calendar with daylight savings time control
- History file with 1,000 event capacity
- Advanced fire technology features:
 - ✓ Automatic drift compensation
 - ✓ Maintenance alert
 - ✓ Detector sensitivity test capability (NFPA 72 compliant)
 - ✓ Automatic device type-code verification
 - ✓ Point trouble identification
- Waterflow selection per module point
- Alarm verification selection per detector point
- Walktest, silent or audible
- PAS (Positive Alarm Sequence) and Pre-signal per point (NFPA 72 compliant)
- Silence inhibit timer option per NAC
- Autosilence timer option per NAC
- Continuous, March Time, Temporal or California code for main circuit board NACs with two-stage capability
- Selectable strobe synchronization per NAC
- Remote Acknowledge, Alarm Silence, Reset and Drill via addressable modules, AFM annunciators or LCD-80F Remote annunciator
- Auto-program (learn mode) reduces installation time. Reports two devices set to the same address
- Password and key-protected nonvolatile memory
- User programmable password
- Fully programmable from local keypad or optional keyboard
- Upload/Download (local or remote) of program and data via integral DACT
- SLC operates up to 10,000 ft. (3,000 m) with twisted, shielded wire or 3,000 ft (900 m) with untwisted, unshielded wire
- Compatible with Fire•Lite's newer series devices
 - ✓ CP350, CP355: addressable Ionization Smoke Detector
 - ✓ SD350(T), SD355(T), AD350 and AD355: addressable Photo Smoke Detector (T= with Thermal Sensor)
 - ✓ H350(R), H355(R), H355HT: Fast Response Heat Detector (R=Rate-of-Rise option, HT=High Temperature 190°F)
 - ✓ D350P(R): addressable Photo Duct Detector (R=alarm relay option)
 - ✓ B501BH & B501BHT Sounder Base
 - ✓ B224RB Relay Base
 - ✓ B224BI Isolator Base
 - ✓ MMF-300: Monitor Module
 - ✓ MMF-300-10: Monitor Module (10 Input Class B or 5 Input Class A)
 - ✓ MDF-300: Dual Monitor Module (uses two consecutive SLC addresses)
 - ✓ MMF-301: Miniature Monitor Module
 - ✓ MMF-302: 2-wire Detector Module
 - ✓ MMF-302-6: 2-wire Detector Module (6 Input Class B or 3 Input Class A)
 - ✓ CMF-300: Control Module
 - ✓ CMF-300-6: Control Module (6 Output Class B or 3 Output Class A)
 - ✓ CRF-300: Relay Module
 - ✓ CRF-300-6: Relay Module (6 Form-C relays)
 - ✓ BG-12LX: Manual Pull Station
 - ✓ I300: Isolator Module

- Compatible with legacy Fire•Lite 300 Series devices:
 - ✓ CP300: addressable Ionization Smoke Detector
 - ✓ SD300(T): addressable Photoelectric Smoke Detector (T= Thermal Sensor)
 - ✓ C304: Control Module
 - ✓ M300: Monitor Module
 - ✓ M301: Miniature Monitor Module
 - ✓ M302: 2-wire Detector Module
 - ✓ BG-10LX: Manual Pull Station
- Optional 4XTMF module (conventional reverse polarity/city box transmitter)
- Annunciators:
 - ✓ ACM Series-LED Zone Annunciators
 - ✓ LDM Graphic Annunciator Series
 - ✓ LCD-80F Liquid Crystal Display point annunciator
 - ✓ ACM-8RF Relay Module

1.2 Specifications

Refer to Illustration on page 10 for terminal locations and connections.

AC Power - TB11

MS-9200UD: 120 VAC, 60 Hz, 3.0 amps

MS-9200UDE: 240 VAC, 50 Hz, 1.5 amps

Wire size: minimum 14 AWG (2.00 mm²) with 600 V insulation

Battery (Lead Acid Only) - J9

Maximum Charging Circuit: Normal Flat Charge - 27.6 VDC @ 0.80 amp

Maximum Battery Charger Capacity: 18 Amp Hour (MS-9200UD cabinet holds maximum of two 18 Amp Hour batteries. For greater than 25 Amp Hour up to 120 Amp Hour batteries, use the CHG-75 or CHG-120F Battery Charger and BB-55F Battery Box.

Note: Jumper JP5, on the FACP main circuit board, must be removed to disable the FACP battery charger when using an external battery charger.

Communication Loop - TB10

24 VDC nominal, 27.6 VDC maximum

Maximum length is 10,000 ft. (3,000 m) total twisted, shielded pair length or 3,000 ft. (900 m) untwisted, unshielded pair length

Maximum loop current is 400 mA (short circuit) or 100 mA (normal)

Maximum loop resistance is 40 ohms

Supervised and power-limited circuit requires ferrite bead per FCC requirement

Refer to SLC Loop manual for wiring information

Notification Appliance Circuits - TB3 & TB4

Each Terminal Block provides connections for two Style Y (Class B) or one Style Z (Class A) for a total of Four Style Y (Class B) or two Style Z (Class A) NACs

Style is configured using NACKEY card plugged into JP6 on main board

Power-limited circuitry

Maximum voltage drop in wiring: 2.0 VDC

Nominal operating voltage: 24 VDC

Current-limit: fuseless, electronic, power-limited circuitry

Maximum signaling current per circuit: 2.5 amps (see Figure 1.1 on page 15)

End-of-Line Resistor: 4.7 k Ω , ½ watt (P/N 71252 UL listed) for Style Y (Class B) NAC

Refer to Fire•Lite Device Compatibility Document for listed compatible devices

Two Programmable Relays and One Fixed Trouble Relay - TB5, TB6 & TB7

Contact rating: 2.0 amps @ 30 VDC (resistive), 0.5 amps @ 30 VAC (resistive)

Form-C relays

Refer to Figure 2.6 on page 32 for information on power-limited relay circuit wiring

Nonresettable Power (24 VDC Nominal) - TB1, Terminals 1 (+) & 2 (-)

Jumper selectable (JP4) for conversion to resettable power output

Maximum ripple voltage: $10mV_{RMS}$

Total DC current available from each output is up to 0.5 amps (see Figure 1.1)

Power-limited circuit requires ferrite bead per FCC requirements

Four-Wire Resettable Smoke Detector Power (24 VDC nominal) - TB3, Terminals 3 (+) & 4 (-)

Maximum ripple voltage: $10mV_{RMS}$

Up to 0.5 amps is available for powering 4-wire smoke detectors (see Figure 1.1)

Power-limited circuit requires ferrite bead per FCC requirements

Refer to Fire•Lite Device Compatibility Document for listed compatible devices

Remote Sync Output - TB2

Remote power supply synchronization output

24 VDC nominal

Maximum current is 40 mA

End-of-Line Resistor: $4.7K\Omega$

Output linked to NAC 1 control

Supervised and power-limited circuit requires ferrite bead per FCC requirements

EIA-485 (TERM) or EIA-232 (ACS) - TB8

EIA-485 Terminal Mode annunciator connections: Terminal 1 (Out +), 2 (In +), 3 (Out -), 4 (In -)

EIA-232 PC/Printer applications connections: Terminal 1 (Transmit), 2 (Receive), 3 (Ground)

EIA-485 (ACS) - TB9

ACS annunciator connector, Terminal 1 (+) and Terminal 2 (-), requires ferrite bead

1.2.1 Current Availability

The following figure illustrates the maximum current that is possible for each panel circuit and the total current available from the FACP with optional second transformer.

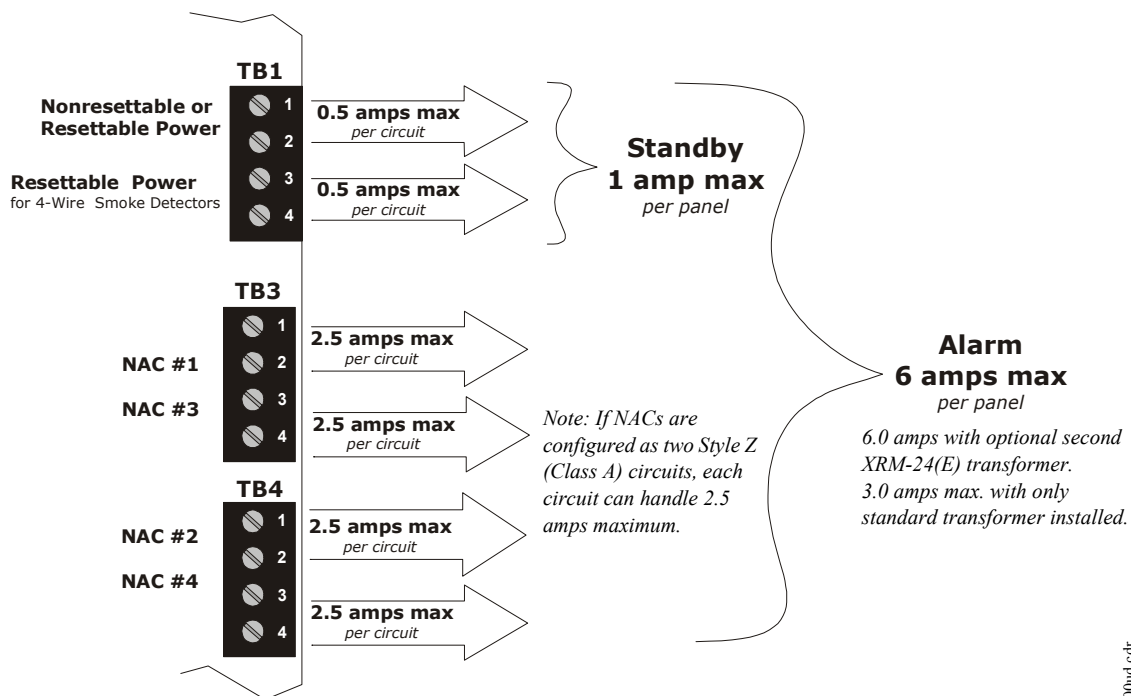

Refer to the battery calculations section for additional information.

Figure 1.1 Current Availability

powerdist9200ud.cdr

1.3 Controls and Indicators

LCD Display

The FACP uses an 80-character (4 lines X 20 characters) high viewing angle LCD display. The display includes a long life LED backlight that remains illuminated. If AC power is lost and the system is not in alarm, the LED backlight will turn off to conserve batteries.



FIRE-LITE ALARMS INC
SYSTEM ALL NORMAL
10:00A 012102

LED Indicators

LED indicators are provided to annunciate the following conditions:

- AC Power (green)
- Fire Alarm (red)
- Supervisory (yellow)
- Trouble (yellow)
- Maintenance/presignal (yellow)
- Alarm Silenced signals (yellow)
- Disabled (yellow)
- Battery fault (yellow)
- Ground fault (yellow)

Key Panel

Mounted on the main circuit board, the key panel includes a window for the LCD display and LED indicators as listed above. The key panel, which is visible with the cabinet door closed, has 25 keys, including a 16 key alpha-numeric pad similar to a telephone keypad.

Function keys:

- Acknowledge/Step
- Alarm Silence
- Drill
- Reset (lamp test)

Service/program keys:

- Keys labeled 1 to 9
- * key
- # key
- 0 (recall) key
- 1st Event key
- Clear key
- Escape key
- Mode key
- Four cursor keys (up, down, left and right)
- Enter key

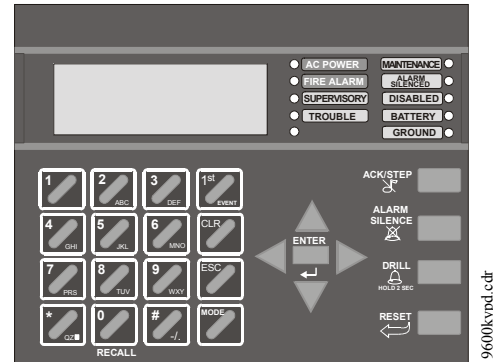

Figure 1.2 Membrane/Display Panel

Local Piezo Sounder

A piezo sounder provides separate and distinct pulse rates for alarm, trouble and supervisory conditions.

1.4 Circuits



SLC Communication Loop

One SLC loop is provided standard on the FACP main circuit board. The SLC loop, configurable for NFPA Style 4, 6 or 7, provides communication to addressable detectors, monitor (initiating device) and control (output device) modules. Refer to the SLC Wiring manual for information on wiring devices.

Output Circuits

The following output circuits are available on the FACP:

- 24 VDC Resettable (smoke detector power) output - 0.5 amps maximum
- 24 VDC Nonresettable or Resettable power output - 0.5 amps maximum
- 24 VDC Battery Charger (up to 18 AH batteries)

NAC (Notification Appliance Circuits)

NACs configurable for four Style Y (Class B) or two Style Z (Class A) using NACKEY card in JP6, are provided with various programmable features.

Relays

One fixed and two fully programmable Form-C dry contact relays are provided. The fixed fail-safe relay monitors system trouble and the two programmable relays are factory default programmed for system alarm and system supervisory. Contacts are rated 2.0 amps @ 30 VDC (resistive) and 0.5 amps @ 30 VAC (resistive). The programmable relays can be programmed for the following operations:

- fire alarm
- trouble
- supervisory
- supervisory auto-resettable
- DACT communication failure
- process monitor
- process monitor auto-resettable
- hazard alert
- medical alert
- AC loss

1.5 Digital Alarm Communicator/Transmitter

Two modular phone jacks allow easy connection to telephone lines. Modular jacks are labeled PH1 for Primary Phone Line and PH2 for Secondary Phone Line. Two telephone line active red LEDs are provided as well as a green *Kissoff* LED. The integral digital communicator provides the following functions:

- Line Seizure: takes control of the phone lines disconnecting any premises phones
- Off/On Hook: performs on and off-hook status to the phone lines
- Listen for dial tone: 440 Hz tone typical in most networks
- Dialing the Central Station(s) number: default is Touch-Tone[®], programmable to rotary
- For tone burst or touchtone type formats: discern proper *Ack* and *Kissoff* tone(s). The frequency and time duration of the tone(s) varies with the transmission format. The control panel will adjust accordingly.
- Communicate in the following formats:
 - ✓ 12 Tone Burst types: 20 pps
(3+1, 4+1, 4+2, 3+1 Exp., 4+1 Exp., 4+2 Exp.)
 - ✓ 3 Touchtone Types
 - 4+1 Ademco Express
 - 4+2 Ademco Express
 - Ademco Contact ID

1.6 Components

Main Circuit Board

The main circuit board contains the system's CPU, power supply, other primary components and wiring interface connectors. The 4XTMF option module plugs in and is mounted to the main circuit board. The circuit board is delivered in the MS-9200UD kit and must be mounted to the backbox (refer to circuit board illustration on page 10).



Cabinet

The MS-9200UD cabinet is red with a navy blue front overlay. The backbox provides space for two batteries (up to 18 Amp Hour). Ample knockouts are provided for system wiring. Also available is an optional dress panel, which mounts to the inside of the cabinet (required by ULC for Canadian installations). The dress panel must be installed to meet FM requirements.



ms9200UD.cdr

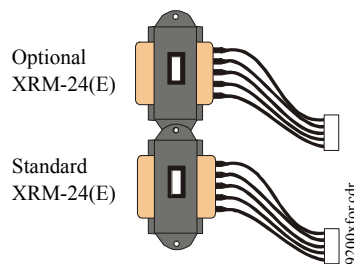

Transformer Assembly

One 100VA transformer is provided standard with the panel (3.6 amps maximum). An optional 100 VA transformer XRM-24 (XRM-24E for the MS-9200UDE) is available to provide maximum system and accessory power (6.6 amp total).

Batteries

The MS-9200UD cabinet provides space for two batteries (up to 18 Amp Hour). Batteries larger than 18 Amp Hour require an external charger such as the CHG-75 or CHG-120F and a UL listed battery box such as the BB-55F. Batteries must be ordered separately.

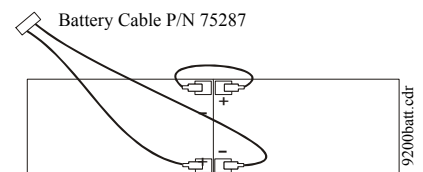

92100batt.cdr

1.6.1 Intelligent Addressable Detectors: Newer Series

Intelligent, addressable detectors provide information to the control panel on an SLC Signaling Line Circuit (refer to the SLC Wiring Manual for detailed information on device installation, wiring and operation). This allows the control panel to continually process the information to determine the status (alarm, trouble, maintenance or normal) of each detector. Each detector responds to an SLC address that is set in the detector head using built-in rotary decimal switches. Note that a blinking LED on an intelligent detector indicates communication between the detector and the control panel. Refer to the Fire•Lite Device Compatibility Document for a list of approved detectors.

Smoke Detectors (Photoelectric)

The SD350 and SD355 are intelligent, addressable low profile photoelectric smoke detectors which provide smoke sensing technology. The SD350T and SD355T include a 135° fixed thermal sensor. The AD350 and AD355 are multicriteria photoelectric smoke detectors with heat sensing capabilities and automatic drift compensation.

Smoke Detector (Ionization)

The CP350 and CP355 are intelligent, addressable low profile ionization smoke detectors which measure the level of combustion products in their chambers using the 'ionization principle.'

Smoke Detector (Duct)

The D350P is an intelligent, addressable photoelectric duct smoke detector. The D350RP includes an alarm relay.

Heat Detectors

The H350 and H355 are intelligent heat detectors with a thermistor sensing circuit for fast response, designed to provide open area protection with 50 foot (15 m) spacing capability. The H350R and H355R incorporate a thermal Rate-of-Rise circuit of 15°F (9.4°C).

Detector Bases

The **B501BH** is a standard sounder base and the **B501BHT** is a temporal tone sounder base for intelligent, addressable smoke detectors.

The **B224RB** is a relay base with one Form-C relay for intelligent, addressable smoke detectors. It may be used to control auxiliary functions.

The **B224BI** is an isolator base for intelligent, addressable smoke detectors. It functions similar to the I300 isolator module which allows loops to operate under fault conditions and automatically restore when the fault is removed.

1.6.2 Intelligent Addressable Modules: Newer Series

The newer series of Control Modules and Monitor Modules provide an interface between the control panel and conventional notification and initiating devices. Each module can be set to respond to an address with built-in rotary switches. A blinking LED on a monitor module indicates communication between the module and the control panel. These devices can also be used when installed on older systems. *Refer to the Fire•Lite Device Compatibility Document for a list of approved notification and initiating devices.*



Reference
Manual

Monitor Modules

The MMF-300, MMF-300-10, MDF-300, MMF-302 and MMF-302-6 are addressable monitor modules for monitoring conventional initiating devices. The MMF-300 is used for normally open contact alarm initiating devices, such as manual pull stations, four-wire smoke detectors, heat detectors, waterflow, security contacts and supervisory devices. The MMF-300-10 functions the same as the MMF-300 except it provides 10 Class B or 5 Class A inputs. The MDF-300 is a dual monitor module (Class B only) which occupies two consecutive SLC addresses, with each module functionally the same as the MMF-300. The MMF-302 is used primarily for two-wire smoke detectors in addition to normally open contact devices. The MMF-302-6 functions the same as the MMF-302 except it provides 6 Class B or 3 Class A inputs. The supervised IDCs (Initiating Device Circuits) can be wired to the modules as NFPA Style B (Class B) or Style D (Class A) circuits. The modules are supplied with a thermoplastic cover for mounting to a 4-inch mounting box.

Monitor Module (miniature)

The addressable MMF-301 module is functionally similar to an MMF-300 but offered in a smaller package for mounting directly in the electrical box of the monitored device.

Control Module

The CMF-300 and CMF-300-6 are an addressable Control Modules used to connect NACs (Notification Appliance Circuits) to power and supervise compatible, UL-listed notification appliances. The CMF-300 provides one Class B or Class A output while the CMF-300-6 provides 6 Class B or 3 Class A outputs. The NACs can be wired to the module as supervised NFPA Style Y (Class B) or Style Z (Class A) circuits. The modules are supplied with a thermoplastic cover for mounting to a 4-inch square mounting box.

Relay Module

The CRF-300 and CRF-300-6 are a Control Relay Modules which are functionally similar to the CMF-300 but used as Form-C relay modules. The CRF-300 provides one Form-C relay while the CRF-300-6 provides six Form-C relays.

Isolator Module

The I300 loop isolator module is an automatic switch which opens the circuit voltage to the SLC loop branch(es) whenever a wire-to-wire short circuit is detected on that loop. The remainder of the communications loop leading up to the I300 will continue to operate, unaffected by the short. The isolator module is bidirectional, meaning that it can detect a fault condition between the input SLC terminals or output SLC terminals. The I300 is required to meet NFPA Style 7 requirements.

Detector Annunciator

The RA400Z is a remote single LED annunciator that can be wired directly to an addressable detector for annunciation of that detector's alarm status.

Manual Pull Station

The BG-12LX is an addressable manual pull station featuring a key-lock reset. The pull station responds to an address set by the installer using the built-in rotary decimal switches on the pull station. The manual pull station includes the Fire•Lite key.

1.6.3 300 Series Intelligent Addressable Devices

Fire•Lite's 300 Series Intelligent Addressable Devices are fully compatible with the MS-9200UD FACP. The address of 300 Series devices cannot be set above 99.

Compatible devices include:

- SD300 Photoelectric Detector
- SD300T Photoelectric Detector with Thermal Sensor
- CP300 Ionization Detector
- M300 Monitor Module
- M301 Miniature Monitor Module
- M302 2-wire Monitor Module
- C304 Control/Relay Module
- BG-10LX Manual Pull Station

1.6.4 Addressable Device Accessories**End-of-Line Resistor Assembly Fire•Lite P/N R-47K**

The 47 k Ω End-of-Line Resistor assembly (P/N: R-47K) is used to supervise the MMF-300, MDF-300, MMF-301 and CMF-300 module circuits. The 3.9 k Ω End-of-Line Resistor assembly is used to supervise the MMF-302 module circuit. The resistors are included with each module.

Power Supervision Relay

The UL listed End-of-Line power supervision relay is used to supervise the power to 4-wire smoke detectors and notification appliances.

N-ELR Mounting Plate

The N-ELR is a single End-of-Line resistor plate. An ELR, which is supplied with each module and fire alarm control panel, is mounted to the ELR plate. Resistors mounted to the N-ELR plate can be used for the supervision of a monitor and control module circuit.

1.7 Optional Modules

The MS-9200UD main circuit board includes option module connectors for the following module:

4XTMF Transmitter Module

The 4XTMF provides a supervised output for local energy municipal box transmitter, alarm and trouble reverse polarity. It includes a disable switch and disable trouble LED. A jumper on the module is used to select an option which allows the reverse polarity circuit to open with a system trouble condition if no alarm condition exists. The module plugs into connectors J5 and J6 which are located near the right edge the main circuit board. When the 4XTMF module is installed, Jumper JP3, on the main circuit board, must be cut to allow supervision of the module.

1.8 Accessories

1.8.1 PK-CD Programming Utility

The PK-CD Programming Utility can be used to program an MS-9200UD directly from most IBM compatible computers, including laptops and portables, equipped with a serial port. MS-9200UD program files can also be created and stored on the PC and then downloaded to the control panel. The PK-CD Kit includes the MS-9200UD Windows-based Programming Utility software on CD-ROM with on-line help file. A serial cable (P/N: PRT/PK-CABLE), which must be purchased separately, is required for connection of the PC to the RS-232 (PC/Printer) terminals at TB8 of the MS-9200UD main circuit board. Refer to the illustration on page 10 and the section titled "Printer/PC" on page 40, for the location and connections to this terminal.

1.8.2 Dress Panel

An optional dress panel is available for the MS-9200UD. The dress panel restricts access to the system wiring while allowing access to the key panel.

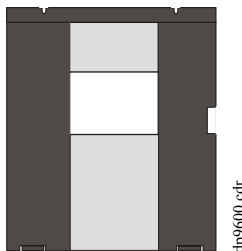

1.8.3 Battery Box

BB-26

The BB-26 battery box may be used to house up to two 26 AH batteries and the CHG-75 Battery Charger. The battery box, which is red and is provided with knockouts, was designed specifically to compliment mounting below the FACP.

BB-55F

The BB-55F battery box may be used to house two 25 AH batteries, two 60 AH batteries or one 100 AH battery. When the CHG-120F is mounted in the BB-55F, two 25 AH or one 60 AH battery may also be housed in the battery box.

1.8.4 Battery Charger

1.8.4.1 CHG-75 Battery Charger

The CHG-75 is capable of charging up to 75 AH lead-acid batteries with the MS-9200UD FACP. The FACP battery charger must be disabled, by removing jumper JP5, when using the CHG-75. The charger and up to 26 AH batteries can be housed in the Fire•Lite BB-26 battery box. Larger batteries and the charger can be housed in the Fire•Lite BB-55F battery box which can be mounted up to 20 feet away from the control panel. Refer to the CHG-75 Manual for additional information.

1.8.4.2 CHG-120F Battery Charger

The CHG-120F is capable of charging up to 120 AH lead-acid batteries with the MS-9200UD FACP. The FACP battery charger must be disabled, by removing jumper JP5, when using the CHG-120F. The batteries and charger can be housed in the Fire•Lite BB-55F battery box which can be mounted up to 20 feet away from the control panel. Note that when using the BB-55F for housing the charger and batteries greater than 25AH, multiple BB-55Fs are required. Refer to the CHG-120F Manual for additional information.



1.8.5 Annunciators

ACM Series LED Zone Type Annunciators

The ACM Series Annunciators remotely display alarm and trouble status as well as system status. In addition, they can provide remote Acknowledge, Silence, Reset and Drill functions. For more detailed information, refer to the appropriate annunciator manual. Following is a list of annunciators which can be used with the MS-9200UD.



- **ACM-16ATF** Annunciator Control Module annunciates 16 zones with 16 red alarm LEDs and 16 yellow trouble LEDs. In addition, it has a System Trouble LED, an On Line/Power LED and a local piezo sounder. It also has switches for FACP Acknowledge, Silence, Reset and Drill. It has rotary address switches and will accept up to three AEM-16ATF Expanders.
- **AEM-16ATF** Annunciator Expander Module annunciates 16 zones with 16 red alarm LEDs and 16 yellow trouble LEDs
- **AFM-16ATF** Annunciator Fixed Module annunciates 16 zones with 16 red alarm LEDs and 16 yellow trouble LEDs. In addition, it has a System Trouble LED, an On Line/Power LED and a local piezo sounder. It also has switches for FACP Acknowledge, Silence, Reset and Drill. It is fixed at address '1.'
- **ACM-32AF** Annunciator Control Module annunciates 32 alarm zones with 32 red LEDs. In addition, it has a System Trouble LED, an On Line/Power LED and a local piezo sounder. It also has a switch for local piezo silence. It has rotary address switches and will accept one AEM-32AF Expander.
- **AEM-32AF** Annunciator Expander Module annunciates 32 alarm zones with 32 red LEDs
- **AFM-16AF** Annunciator Fixed Module annunciates 16 alarm zones with 16 red alarm LEDs. In addition, it has a System Trouble LED, an On Line/Power LED and a local piezo sounder. It also has a switch for local piezo silence. It is fixed at address '1.'
- **AFM-32AF** Annunciator Fixed Module annunciates 32 alarm zones with 32 red LEDs.

LCD-80F Remote Fire Annunciator

The LCD-80F annunciator is a compact 80-character backlit LCD remote fire annunciator that is capable of displaying English language text. It mimics the display on the control panel and will announce device type, point alarm, trouble or supervisory condition, zone assignment plus any custom alpha labels programmed into the FACP. The annunciator also provides system status LEDs to display AC Power, Alarm, Trouble, Supervisory and Alarm Silenced conditions. Additionally, the LCD-80F is capable of remotely performing critical system functions such as Acknowledge, Silence, Reset and Drill.

Communications between the control panel and the annunciator is accomplished over a serial interface employing the EIA-485 communication standard. Up to 32 LCD-80F annunciators may be connected to the EIA-485 circuit. The annunciators may be powered from the host FACP or a remote UL listed filtered power supply such as the Fire•Lite FCPS Series. For more detailed information, refer to the LCD-80F manual.



LDM Series Lamp Driver Modules (Graphic Annunciator)

The LDM Series Lamp Driver Modules, which consist of the LDM-32F master and LDM-E32F expander modules, are used to provide an interface to a custom graphic LED annunciator. The master module provides power and control for a maximum of three expander modules. The LDM-32F and LDM-E32F have output connectors which are used to drive lamps or LEDs and input connectors which are used for remote switch functions. Refer to the LDM Series Lamp Driver Modules manual for a complete description.



1.9 Getting Started

The following is a brief summary of the minimal steps involved in bringing an MS-9200UD on-line:

- Install Backbox and Main Circuit Board (refer to "Mounting Backbox" on page 27)
- Address and Install Intelligent Devices (refer to the SLC Wiring Manual)
- Enter Autoprogramming (refer to "Autoprogram" on page 49)
- Resolve Programming Conflicts
- Go to Point Program to Enter Specific Data (refer to "Point Program" on page 50). Use the right and left arrow keys to navigate between devices.

1.10 Telephone Requirements and Warnings

1.10.1 Telephone Circuitry

Ringer Equivalence Number (REN) = 0.0B
AC Impedance: 10.0 Mega Ohm
Complies with FCC Part 68
Mates with RJ31X Male Connector
Supervision Threshold: less than 4.0 volts for 2 minutes

The REN is used to determine the quantity of devices which may be connected to the telephone line. Excessive RENs on the telephone line may result in the devices not ringing in response to an incoming call. In most, but not all areas, the sum of the RENs should not exceed five (5.0). To be certain of the number of devices that may be connected to the line as determined by the total RENs, contact the telephone company to determine the maximum REN for the calling area.

1.10.2 Digital Communicator

Before connecting the control panel to the public switched telephone network, the installation of two RJ31X jacks is necessary. If trouble is experienced with this equipment, for repair or warranty information, please contact:

Manufacturer: Fire•Lite Alarms, Inc.
One Fire-Lite Place
Northford, CT 06472
(203) 484-7161

Product Model Number: **MS-9200UD**
FCC Registration Number: **US:1W6AL00B9200UD**
Ringer Equivalence: **0.0B**

*Note: This equipment complies with Part 68 of the FCC rules and the requirements adopted by the ACTA. On the inside of the FACP door is a label that contains, among other information, a product identifier in the format **US:AAAEQ##TXXXX**. If requested, this number must be provided to the telephone company.*

Alarm dialing equipment must be able to seize the telephone line and place a call in an emergency situation. It must be able to do this even if other equipment (telephone, answering system, computer modem, etc.) already has the telephone line in use. To do so, alarm dialing equipment must be connected to a properly installed RJ31X jack that is electrically in series with and ahead of all other equipment attached to the same telephone line. If there are any questions concerning these instructions, consult the telephone company or a qualified installer about installing the RJ31X jack and alarm dialing equipment. Refer to "Digital Communicator" on page 36 for an illustration of the proper installation of this equipment.

1.10.3 Telephone Company Rights and Warnings

The telephone company, under certain circumstances, may temporarily discontinue services and/or make changes in its facilities, services, equipment or procedures which may affect the operation of this control panel. However, the telephone company is required to give advance notice of such changes or interruptions.

If the control panel causes harm to the telephone network, the telephone company reserves the right to temporarily discontinue service. Advance notification will be provided except in cases when advance notice is not practical. In such cases, notification will be provided as soon as possible. The opportunity will be given to correct any problems and to file a complaint with the FCC if you believe it is necessary.

DO NOT CONNECT THIS PRODUCT TO COIN TELEPHONE, GROUND START, OR PARTY LINE SERVICES.

When the control panel activates, premise phones will be disconnected.

Two separate phone lines are required. Do not connect both telephone interfaces to the same telephone line.

The control panel must be connected to the public switched telephone network upstream (as first device) of any private telephone system at the protected premises.

A plug and jack used to connect this equipment to the premises wiring and telephone network must comply with the applicable FCC Part 68 rules and requirements adopted by ACTA. This equipment is designed to be connected to the telephone network or premises wiring using a compliant RJ31X male modular plug and compatible modular jack that is also compliant.

SECTION 2 Installation

The cabinet may be either semi-flush or surface mounted. The cabinet mounts using two key slots and two 0.250" (6.35 mm) diameter holes located in the backbox. The key slots are located at the top of the backbox and the two securing holes at the bottom.

Carefully unpack the system and check for shipping damage. Mount the cabinet in a clean, dry, vibration-free area where extreme temperatures are not encountered. The area should be readily accessible with sufficient room to easily install and maintain the panel. Locate the top of the cabinet approximately 5 feet (1.5 m) above the floor with the hinge mounting on the left. Determine the number of conductors required for the devices to be installed. Sufficient knockouts are provided for wiring convenience. Select the appropriate knockout(s) and pull the conductors into the box. All wiring should be in accordance with the National and/or Local codes for fire alarm systems.

2.1 Mounting Backbox



The circuit board contains static-sensitive components. Always ground yourself with a proper wrist strap before handling any boards so that static charges are removed from the body. Use static suppressive packaging to protect electronic assemblies.



- ✓ Mark and predrill holes in the wall for the top two keyhole mounting bolts using the dimensions illustrated in Figure 2.3 on page 29
- ✓ Install two upper fasteners in the wall with the screw heads protruding
- ✓ Using upper 'keyholes,' place backbox over the two screws, level and secure
- ✓ Mark and drill the lower two holes
- ✓ Install remaining fasteners and tighten
- ✓ Screw supplied standoffs onto mounting studs in locations indicated below
- ✓ When the location is dry and free of construction dust, install the main circuit board by aligning the 8 mounting holes in the circuit board with the 8 mounting standoffs in the backbox as illustrated below
- ✓ Secure the circuit board to the standoffs with the supplied screws as indicated in following figure

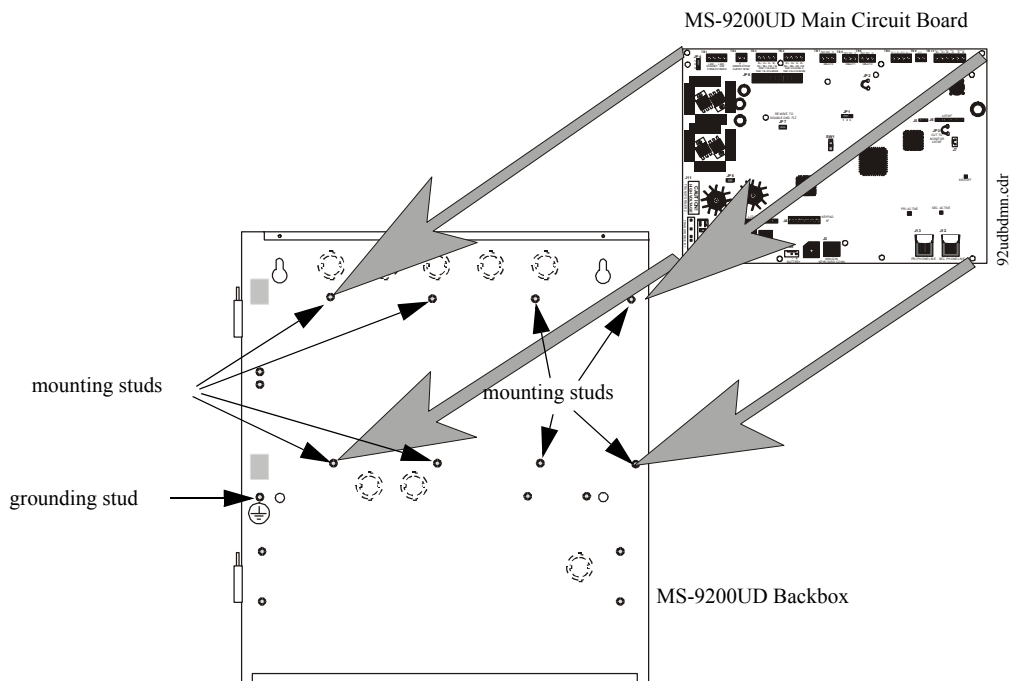

Figure 2.1 MS-9200UD Main Circuit Board Installation

2.2 Mounting Transformer

One XRM-24(E) transformer is supplied standard with the control panel. An optional second XRM-24(E) transformer can be ordered and installed to provide maximum system power. Install the transformers in the locations indicated in the following illustration.

1. Mount the Standard XRM-24 Transformer in the lower transformer mounting location by positioning the wiring connector to the right as illustrated in the following figure.
2. Slide the bottom transformer mounting bracket into the embossed mounting pocket as illustrated.
3. Secure the top transformer mounting bracket to the mounting stud with the supplied screw.
4. If the optional second XRM-24 Transformer is being installed, mount it in the upper transformer mounting location by positioning the wiring connector to the right as illustrated in the following figure.
5. Slide the top transformer mounting bracket into the embossed mounting pocket as illustrated.
6. Secure the bottom transformer mounting bracket to the mounting stud with the supplied screw.
7. Connect the Standard XRM-24 Transformer plug to Transformer 1 Connector J10 on the FACP main circuit board.
8. Connect the Optional XRM-24 Transformer plug to Transformer 2 Connector J11 on the FACP main circuit board.
9. Complete the installation as detailed in the following sections.

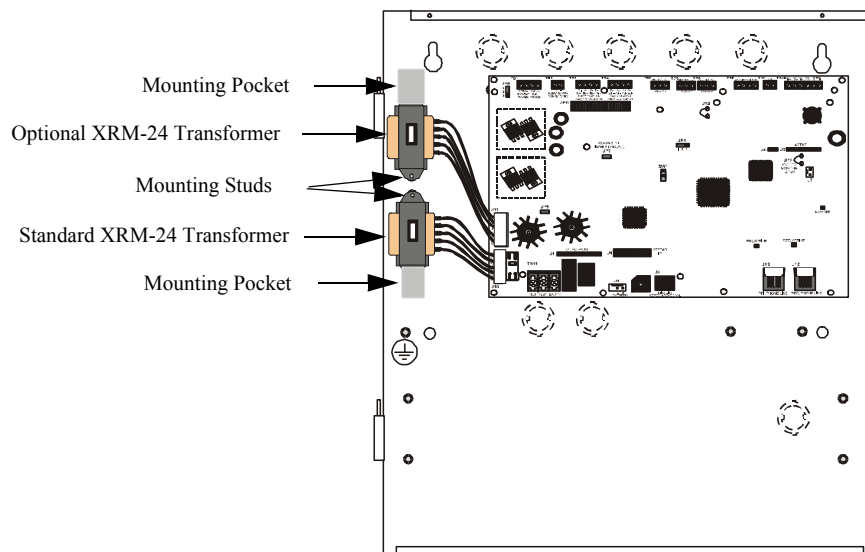

Figure 2.2 Transformer Mounting

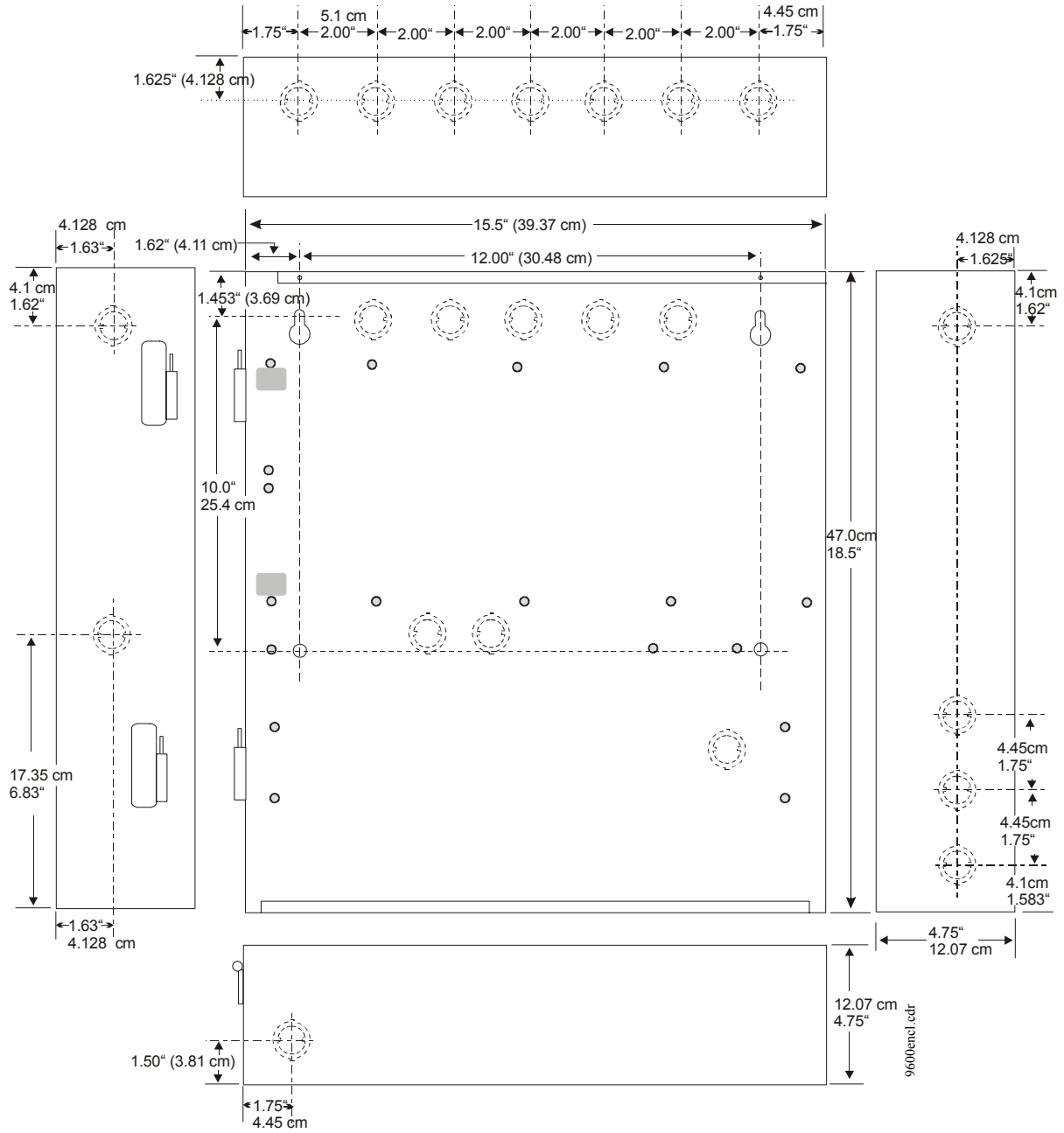

Figure 2.3 MS-9200UD Cabinet Mounting

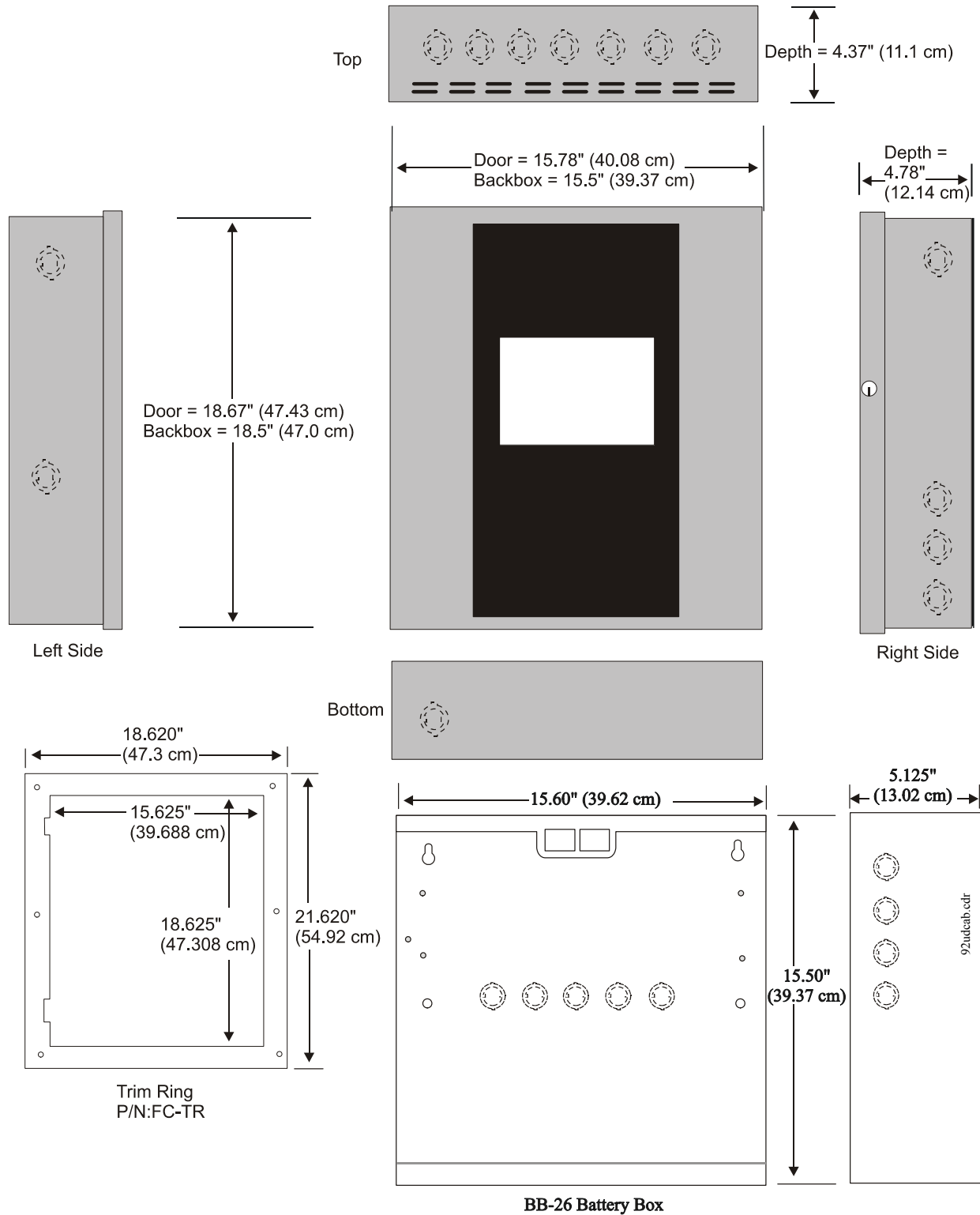

Figure 2.4 MS-9200UD Cabinet Dimensions

Note that the BB-26 Battery Box was designed specifically to compliment mounting below the FACP.

2.3 Power



WARNING: Several different sources of power can be connected to this panel. Disconnect all sources of power before servicing. The panel and associated equipment may be damaged by removing and/or inserting cards, modules or interconnecting cables while this unit is energized.

2.3.1 AC Power and Earth Ground Connection

Primary power required for the FACP is 120 VAC, 60 Hz, 3.0 amps for the MS-9200UD or 240 VAC, 50 Hz, 1.5 amps for the MS-9200UDE.

Overcurrent protection for this circuit must comply with Article 760 of the National Electrical Code (NEC) and/or local codes. Use 14 AWG (2.00 mm²) or larger wire with 600 volt insulation rating.

Make certain that the AC mains circuit breaker is off before wiring any connections between the mains and the control panel. Connect wiring from the AC mains to TB11 on the FACP, being careful to observe proper connections.

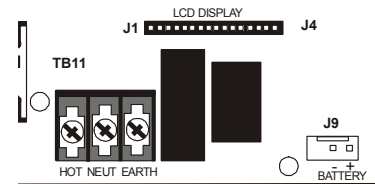

Connect a wire from the grounding stud in the cabinet to a known solid earth ground in the building. Refer to Figure 2.1 on page 27 for location of the stud. This connection is vital for maintaining the control panel's immunity to unwanted transients generated by lightning and electrostatic discharge. Apply AC power to the panel only after the system is completely installed and visually checked. *Note that AC power must be applied to the panel before installing the battery interconnect cable (refer to the following section).*

2.3.2 Battery Power

Before connecting the batteries to the FACP, make certain that the interconnect cable between the batteries is not connected. Do not connect the interconnect cable until the system is completely installed. Observe polarity when connecting the batteries. Connect the battery cable to J9 on the main circuit board. Refer "Power Supply Calculations" on page 165, for calculation of the correct battery rating.

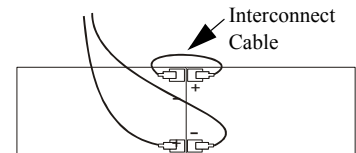

WARNING: Battery contains sulfuric acid which can cause severe burns to the skin and eyes and can destroy fabrics. If contact is made with sulfuric acid, immediately flush the skin or eyes with water for 15 minutes and seek immediate medical attention.

2.3.3 DC Power Output Connection

All DC power outputs are power-limited and require a ferrite bead per FCC requirements (refer to "UL Power-limited Wiring Requirements" on page 35).

Power-limited Resettable or Nonresettable Power
0.5 amperes max., 24 VDC nominal filtered, resettable or nonresettable power can be drawn from TB1 Terminals 1(+) and 2(-)

Power-limited Resettable Power
0.5 amperes max., 24 VDC nominal filtered, resettable power can be drawn from TB1 Terminals 3(+) and 4(-)

JP4 is used to configure TB1, Terminals 1 & 2 for:

- Resettable Power - jumper pins 1 and 2 of JP4 as shown
- Nonresettable Power - jumper pins 2 & 3 of JP4

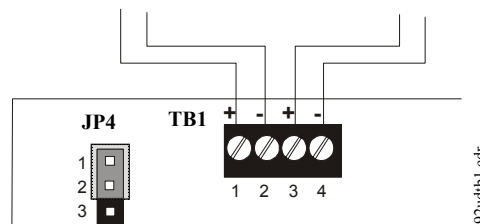

Figure 2.5 Power Outputs - 24 VDC

2.4 Relays

The FACP provides two programmable Form-C relays and one fixed fail-safe Form-C trouble relay, all with contacts rated for 2.0 amps @ 30 VDC (resistive) or 0.5 amps @ 30 VAC (resistive).

Note that relay connections may be power-limited or nonpower-limited, provided that 0.25" spacing is maintained between conductors of power-limited and nonpower-limited circuits. Refer to UL Power-limited wiring requirements.

Note that the programmable relay labeled as Relay 1 is factory default programmed as Alarm and programmable Relay 3 is factory default programmed as Supervisory. The relay labeled Relay 2 is fixed as a Trouble relay and cannot be changed. It is a fail-safe relay which will transfer on any trouble or total power failure.

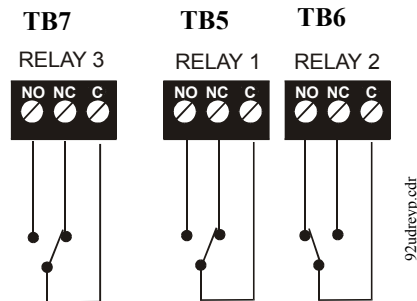

Relay contacts shown with power applied to panel and no active troubles, alarms or supervisories

Figure 2.6 Relay Terminals

2.5 Notification Appliance Circuits



See Page



Reference Manual

The control panel provides four Style Y (Class B) or two Style Z (Class A) NACs (Notification Appliance Circuits). Each circuit is capable of 2.5 amps of current. Total current in alarm for all external devices cannot exceed 6.0 amps (refer to "Calculating the System Current Draw" on page 166). Use UL listed 24 VDC notification appliances only. Circuits are supervised and power-limited. Refer to the Fire•Lite Device Compatibility Document for a listing of compatible notification appliances. The NACs, which are located on the main circuit board, may be expanded via the Fire•Lite FCPS Series field charger/power supplies.

The following sections describe the configuration and wiring of Style Y and Style Z Notification Appliance Circuits on the MS-9200UD main circuit board. The NACs are configured for Style Y (Class B) from the factory. Refer to "Configuring NACs" on page 33 for information on changing the NAC configuration to Style Z (Class A).

2.5.1 Configuring NACs

The Notification Appliance Circuits on the main circuit board are configured for Style Y (Class B) or Style Z (Class A) by properly orienting the NACKEY card in JP6 which is located at the top of the main circuit board near the NAC terminal blocks TB3 and TB4. The default configuration is for Style Y (Class B). Refer to Figure 2.7 for information on installing the NACKEY card.

- Style Z (Class A) - install NACKEY into JP6 with Class A pointing down toward circuit board as illustrated to the right.
- Style Y (Class B) - install NACKEY into JP6 with Class B pointing down toward circuit board.

NACKEY must be inserted with text side facing in toward center of main circuit board and key into key-slot as illustrated to the right. It is keyed to prevent incorrect insertion.

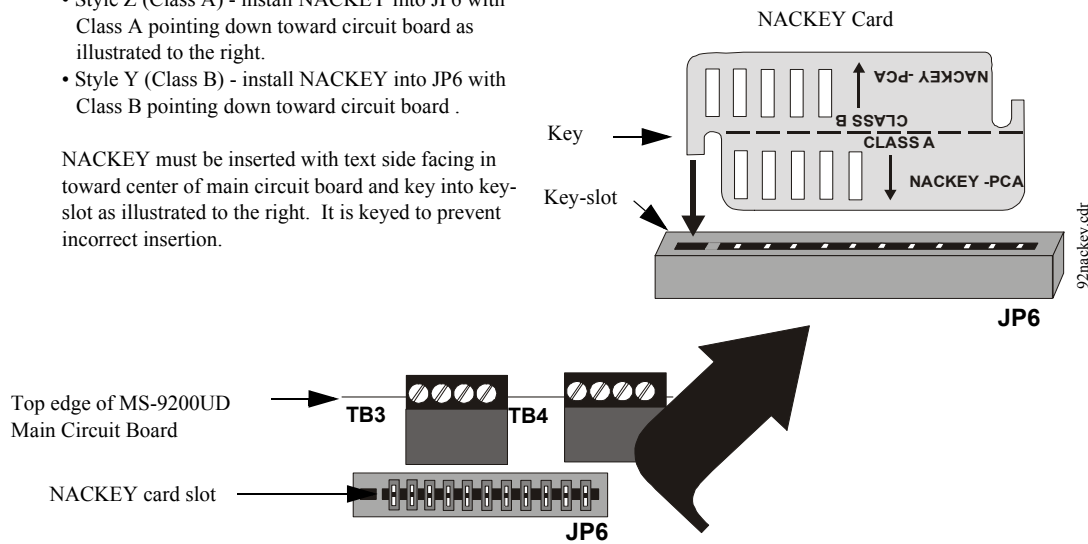

Figure 2.7 NAC Configuration Using NACKEY

2.5.2 Style Y (Class B) NAC Wiring

4 Style Y (Class B) Notification Appliance Circuits, supervised and power-limited - 4.7 kΩ, ½ watt P/N:71252 UL listed

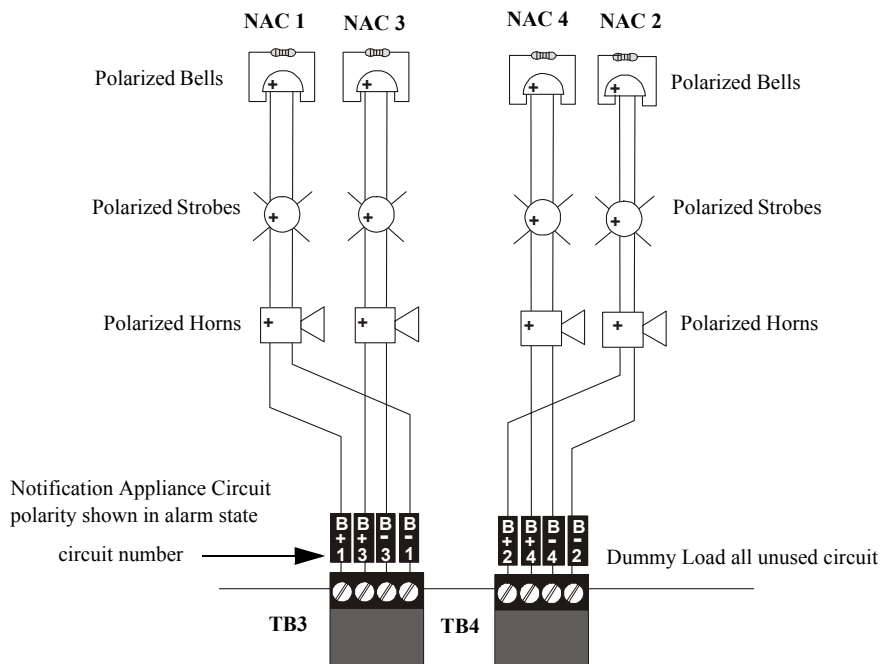

Figure 2.8 NAC Style Y (Class B) Wiring

2.5.3 Style Z (Class A) NAC Wiring

2 Style Z (Class A) Notification Appliance Circuits, supervised and power-limited

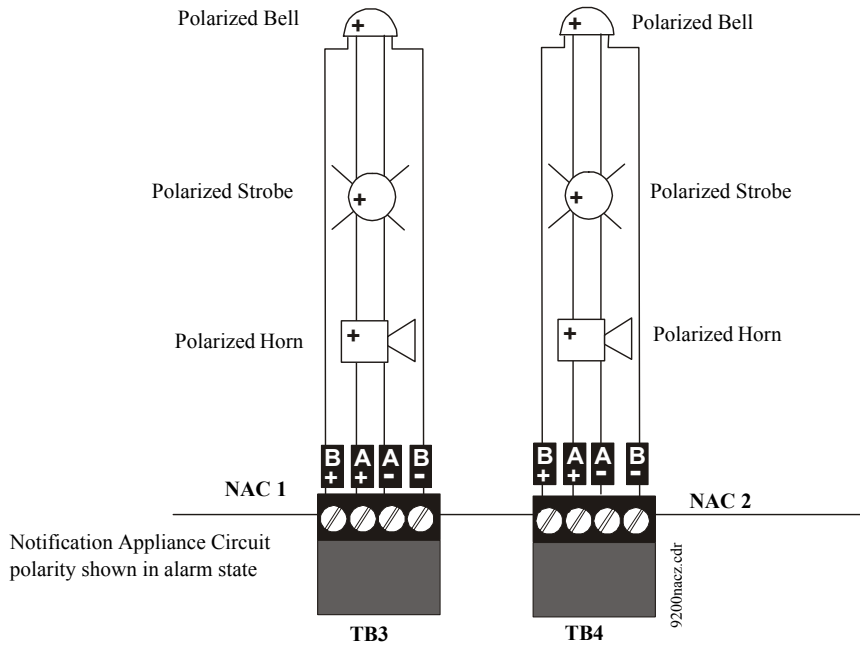

Figure 2.9 NAC Style Z (Class A) Wiring

2.6 Remote Synchronization Output

Synchronization is a feature that controls the activation of notification appliances in such a way that all devices will turn on and off at exactly the same time. This is particularly critical when activating strobes which must be synchronized to avoid random activation and a potential hazard to individuals. Devices connected directly to the control panel's NACs can be synchronized as described in "Type" on page 90.

Notification appliances connected to remote power sources may require synchronization with the FACP's devices. This can be accomplished by connecting the Remote Synchronization Output from TB2 of the MS-9200UD to a compatible sync input of a power supply such as the FCPS-24FS6/8. The 24 VDC, 40 mA signal from TB2 follows, that is mimics, the signal on NAC1. This allows the devices connected to the power supply to be synchronized with the devices connected to NAC1 on the FACP.

The Remote Synchronization Output is power-limited and supervised and requires a ferrite bead (refer to "UL Power-limited Wiring Requirements" on page 35). A 4.7 kΩ resistor must be connected to the end of the wiring at the remote power supply.

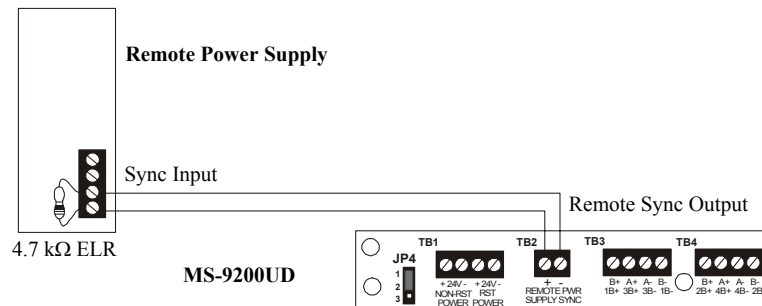
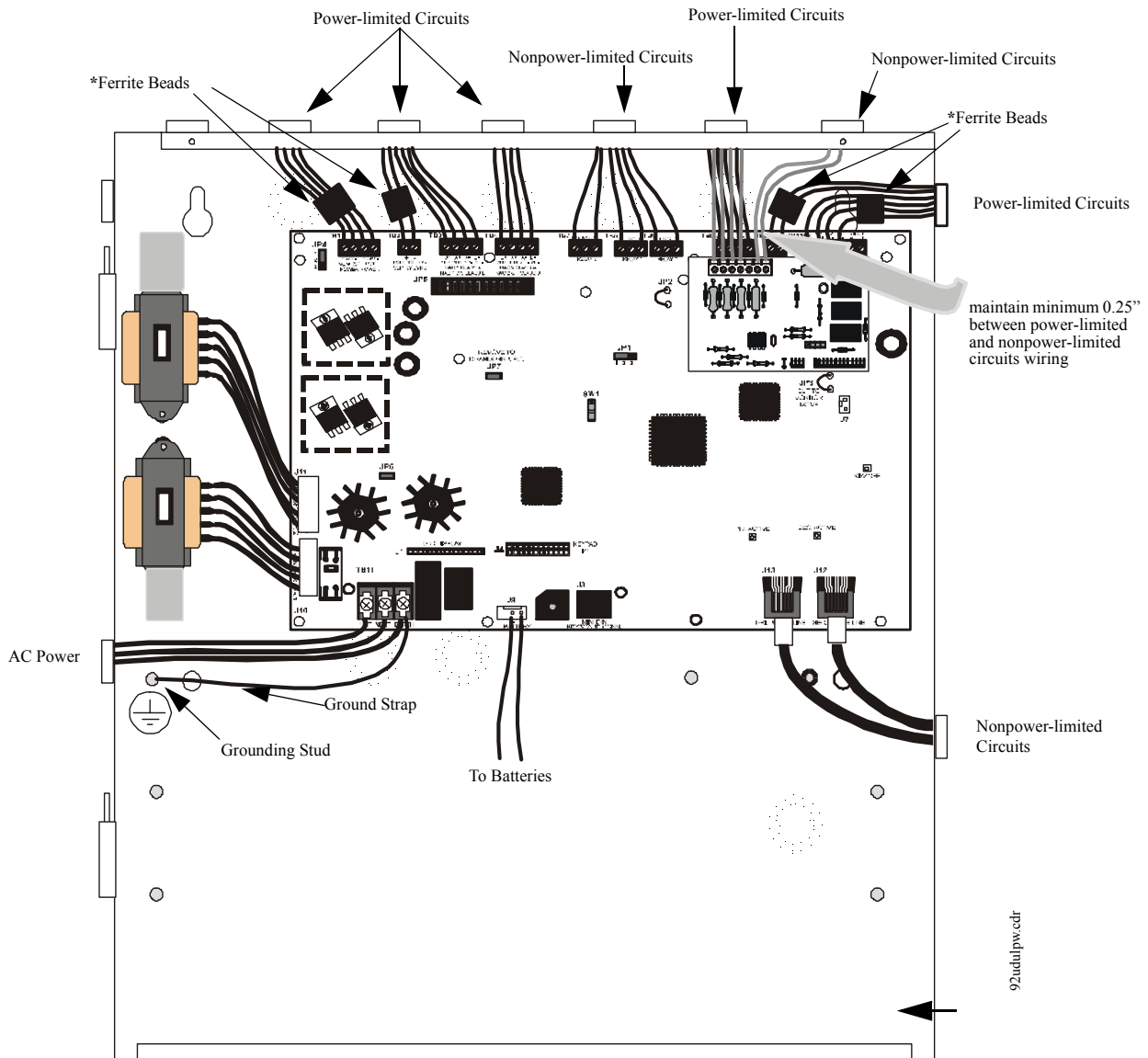

Figure 2.10 Remote Sync Output

2.7 UL Power-limited Wiring Requirements

Power-limited and nonpower-limited circuit wiring must remain separated in the cabinet. All power-limited circuit wiring must remain at least 0.25" (6.35 mm) away from any nonpower-limited circuit wiring and nonpower-limited circuit wiring must enter and exit the cabinet through different knockouts and/or conduits. A typical wiring diagram for the MS-9200UD is shown below.

FIGURE 2-1: Typical UL Power-limited Wiring Requirements



*Ferrite Bead Installation

Per FCC requirements, ferrite beads are required for the DC Power Outputs, Remote Power Supply Sync, ACS Output and SLC Circuit.

Wrap wire around ferrite bead as shown.

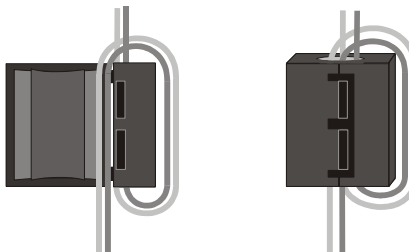

2.8 Digital Communicator

Two independent telephone lines can be connected to the control panel. Telephone line control/command is made possible via double line seizure as well as usage of an RJ31X style interconnection. *Note that it is critical that the panel's digital communicator be located as the first device on the incoming telephone circuit to properly function.*

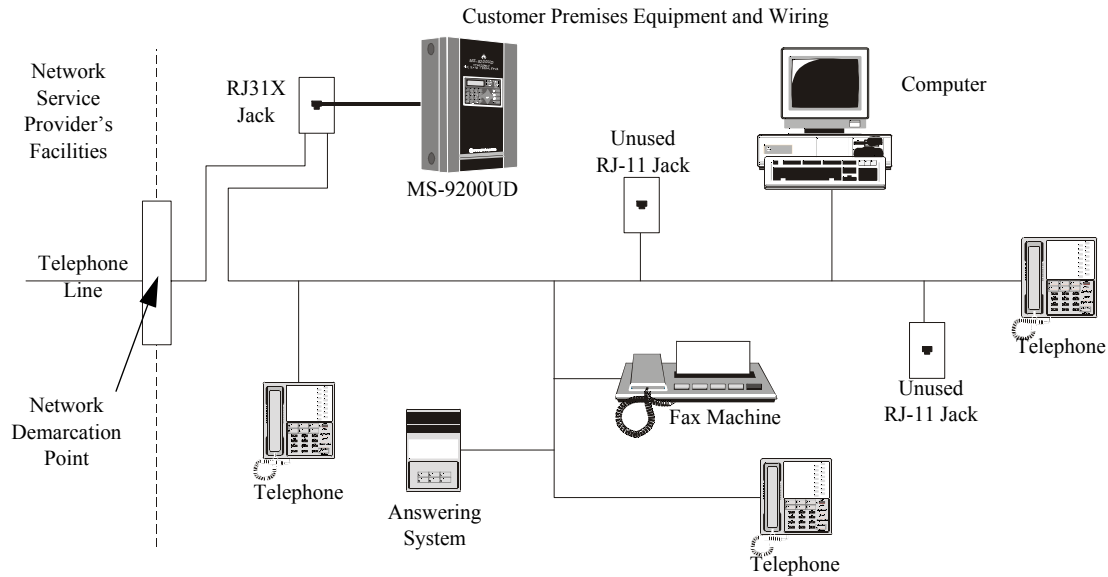

Figure 2.1 DACT Installation

The control panel's digital communicator is built into the main circuit board. Connection and wiring of two phone lines is required as shown below.

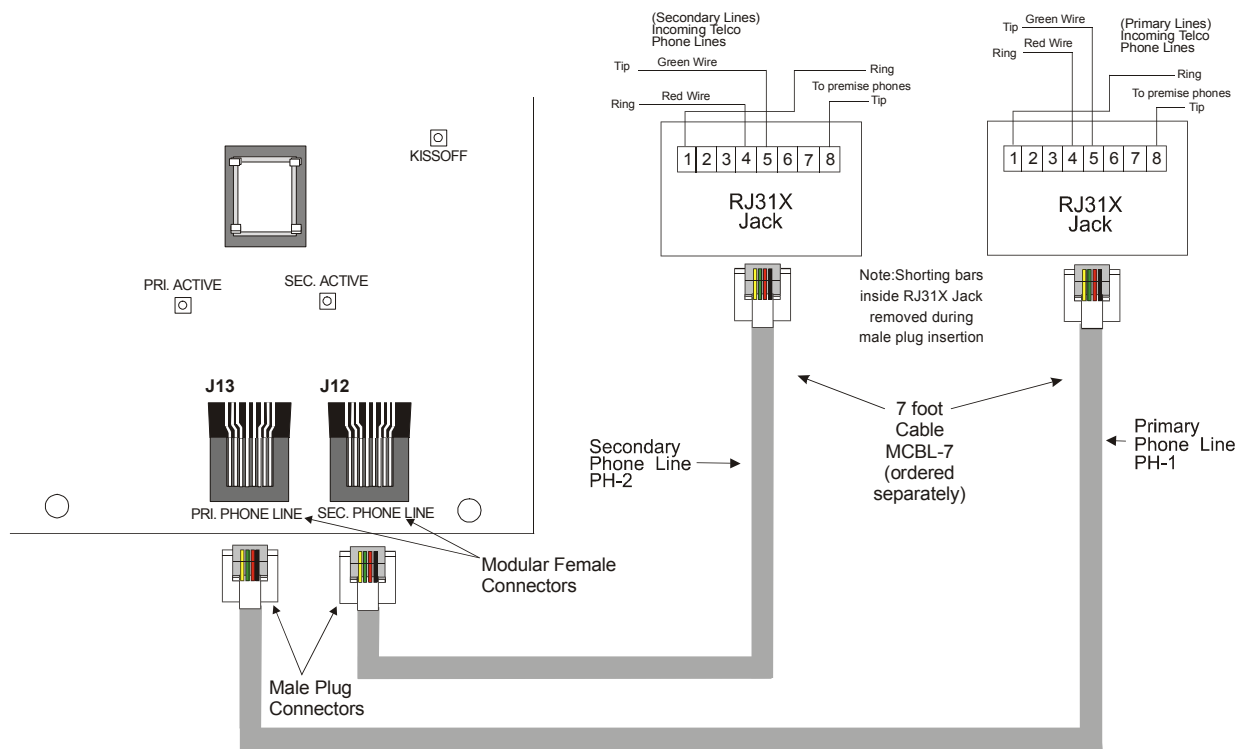

Figure 2.2 Wiring Phone Jacks

2.9 Optional Module Installation

⚡ WARNING! Disconnect all sources of power (AC and DC) before installing or removing any modules or wiring.

MS-9200UD Keypad/Display Removal

Removal of the keypad/display is normally not necessary. If, however, it becomes necessary to replace the keypad/display or access jumpers JP5 and JP7 or switch SW1, the Keypad/Display can be removed by inserting a Phillips screwdriver into each of the three holes located in the flexible covering of the Keypad/Display and loosening the three mounting screws. Note that it is not necessary to disconnect the cables between the Keypad/Display and the main circuit board unless the unit itself is being replaced. Carefully lift the Keypad/Display and rest the unit at the bottom of the main circuit board.

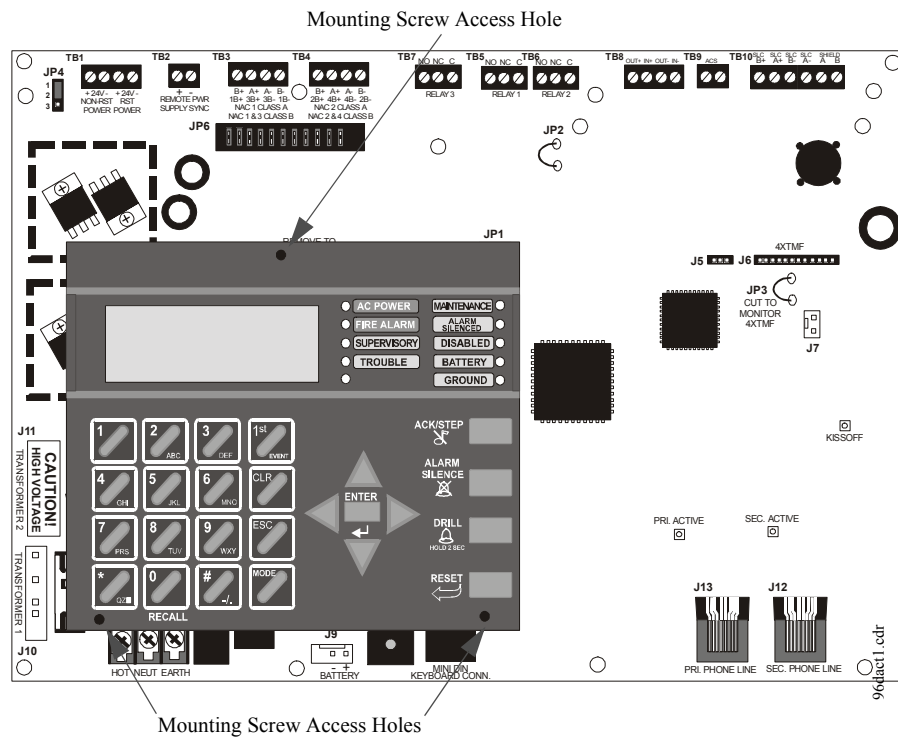

Figure 2.3 Keypad/Display Removal

2.9.1 4XTMF Transmitter Module Installation

The 4XTMF provides a supervised output for a local energy municipal box transmitter in addition to alarm and trouble reverse polarity. A jumper option allows the reverse polarity circuit to open with a system trouble condition if no alarm condition exists. A disable switch allows disabling of the transmitter output during testing to prevent accidental calling of the monitoring service.

Local Energy Municipal Box Service (NFPA 72 Auxiliary Fire Alarm Systems):

- Supervisory Current: 5.0 mA
- Trip Current: 350 mA (subtracted from notification appliance power)
- Coil Voltage: 3.65 VDC
- Maximum Coil Resistance: 14.6 ohms
- Maximum allowable wire resistance between panel and trip coil: 3 ohms
- Municipal Box wiring can leave the building

Remote Station Service (NFPA 72 Remote Station Fire Alarm Systems) - Intended for connection to a polarity reversal circuit or a Remote Station receiving unit having compatible ratings:

- Maximum load for each circuit: 10 mA
- Reverse polarity output voltage: 24 VDC
- Remote Alarm and Remote Trouble wiring can leave the building

Before installing the module, place the disconnect switch to the right (disconnect) position to prevent accidental activation of the municipal box. Note that a Disconnect LED will illuminate after the module is installed in the MS-9200UD. In addition, the System Trouble LED will turn on to indicate the Disconnect condition.

Note: 4XTMF Module is not suitable for transmitting reverse polarity supervisory signal.

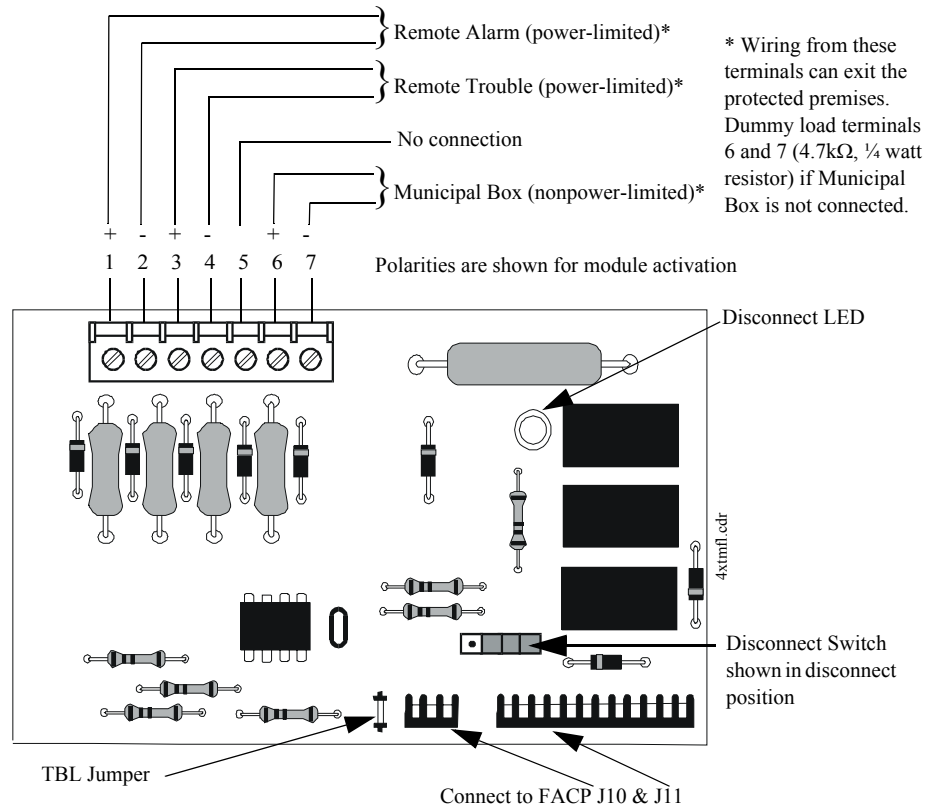

Figure 2.4 4XTMF Transmitter Module

The following steps must be followed when installing the 4XTMF module:



1. Remove all power (Primary and Secondary) from the FACP before installing 4XTMF
2. Cut jumper JP3 on the main circuit board to allow the control panel to supervise the 4XTMF module
3. Carefully plug the connectors on the 4XTMF module into connectors J5 and J6 on the MS-9200UD main circuit board, being careful not to bend any pins
4. Secure 4XTMF module to standoffs with supplied screws.
5. Reapply power to the FACP
6. For proper 4XTMF operation, the output relays must be programmed for the factory default settings: Alarm Relay 1, Trouble Relay 2 and Supervisory Relay 3
7. When the installation has been complete, enable the 4XTMF module by sliding the disconnect switch to the left
8. Test system for proper operation

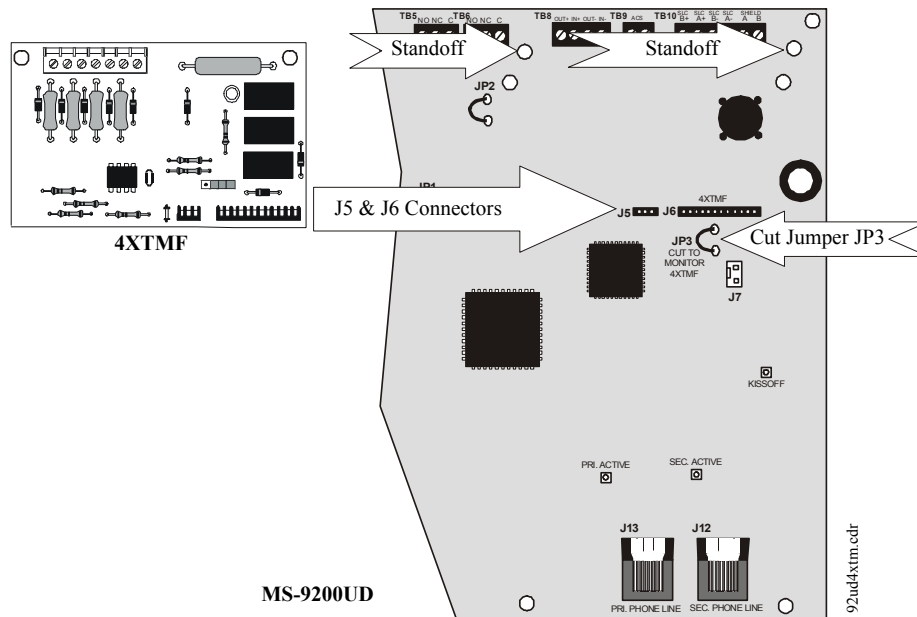

Figure 2.5 4XTMF Connectors to MS-9200UD Connectors

NOTE: Jumper JP2 on the MS-9200UD main circuit board can be used to configure the FACP supervisory relay for operation with the 4XTMF module. Relay 3 at TB5 must be programmed as a supervisory relay. Cutting JP2 will allow the 4XTMF to generate a trouble if the supervisory contact opens. Leaving JP2 in will prevent generation of a trouble if the supervisory contact opens.

2.9.2 Printer/PC

A serial printer or a PC (personal computer) may be connected to TB8 Terminals 1 - 4 on the FACP. The printer can be used to provide a hard-copy printout of real-time events, history file and walktest data. An IBM compatible PC can be connected to provide local FACP programming capabilities using the PK-CD programming utility. Installation of either device requires panel programming to allow the FACP to communicate with the device.



CAUTION! Do not connect a printer or PC to the MS-9200UD FACP if a ground fault exists on the control panel. Circuit damage may result. Remove all power (Primary and Secondary) before installing or removing any wiring.

Installation

Remote printers and PCs require separate primary power. Also required is the PRT/PK-CABLE which is an interface cable prewired to a DB9F connector. Wire the PRT/PK-CABLE to TB8 Terminals 1 - 4 as illustrated in the following figure. Connect the DB9F connector to the printer or PC serial EIA-232 port. If a nine-pin serial connector is not available on the printer or PC, use a DB25 adapter. Make certain that the DB25 adapter does not swap the Transmit and Receive lines. Apply power to the FACP and printer or PC. Note that a ground fault may occur on the FACP, dependent on the printer or PC being used, due to this connection. For this reason, it is important that there be no preexisting ground fault on the panel.

Note that the printer may or may not be supervised as determined by user programming. Refer to "Printer/PC" on page 117.

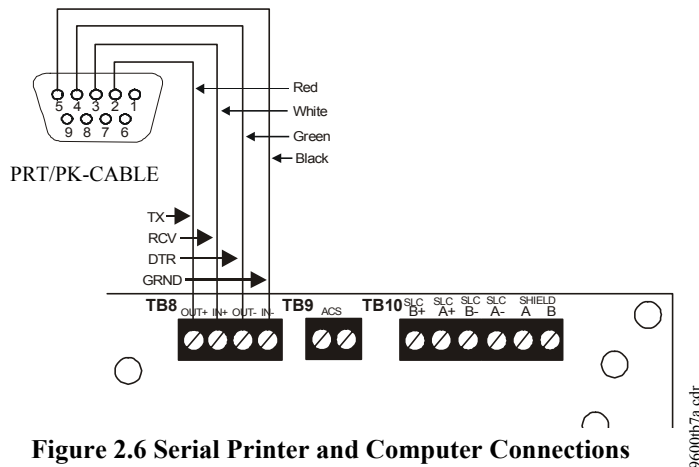

Figure 2.6 Serial Printer and Computer Connections

Printer Configuration

Refer to the documentation supplied with the printer for pertinent information about printer setup. Set the printer's options as listed in the following table:

COMMUNICATION SETUP	
BUFFER:	LARGE
DATA BITS:	7
PARITY:	EVEN
STOP BIT:	1 STOP
BAUD RATE:	2400/4800/9600
AUTOMATIC LINE FEED	NO
AUTOMATIC CARRIAGE RETURN	NO

PC Configuration

The Windows-based PK-CD Programming Utility Kit contains CD-ROM with on-line help file.

2.9.3 Digital Communicator and Annunciators

2.9.3.1 ACM-8RF Relay Control Module

The ACM-8RF module provides eight Form-C relays with contacts rated for 5 amps. When installed with an MS-9200UD FACP, the ACM-8RF modules provide relay activation for each of the 99 possible FACP zones plus special functions. Options exist to allow for alarm only or alarm and trouble activation per zone. Output activation for general alarm, general trouble, general supervisory, NAC fault, AC fail, walktest start and battery trouble are also available. The ACM-8RF can be mounted remotely in an ABS-8RF annunciator surface-mount backbox or in the panel cabinet using the P/N: BRKT-9600 Universal Bracket. Refer to the ACM-8RF manual for information on setting module switches for addressing and relay functions.



2.9.3.2 BRKT-9600 Universal Bracket Installation

The optional BRKT-9600 Universal Bracket can be used to mount specific modules inside the MS-9200UD cabinet. The BRKT-9600 mounts to two studs located in the lower right corner of the control panel cabinet as illustrated below. It is secured to the PEM studs on the back wall of the cabinet with two supplied hex nuts.

IMPORTANT! When the BRKT-9600 is installed, the MS-9200UD cabinet can hold a maximum of two 12 Amp Hour batteries with the orientation illustrated:

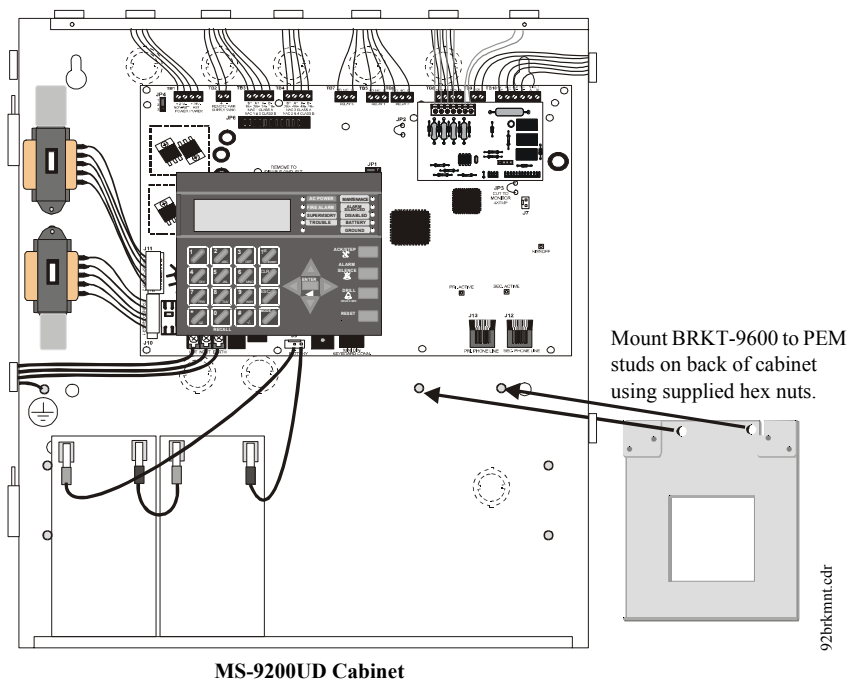

Figure 2.7 BRKT-9600 Bracket Installation

Module Installation on BRKT-9600

The following modules can be installed inside the MS-9200UD cabinet using the BRKT-9600 Universal Bracket:

- ✓ UDACT-F Digital Alarm Communicator/Transmitter - installs at standoff location (A)
- ✓ ACM-8RF Annunciator Control Module (Relay) - installs at standoff location (A)

Refer to the appropriate module manual for detailed information on module operation and wiring.

1. Install the two supplied standoffs in location (A) as indicated in Step 1 of the following illustration
2. Position the module bottom in the slot located in the bottom of the BRKT-9600 as indicated in Step 2 of the following illustration
3. Secure the module to the standoffs installed in the top of the BRKT-9600 with two mounting screws as indicated in Step 3 of the following illustration
4. Refer to the appropriate module manual for detailed information on wiring the module for power, communication, etc.
5. Install a maximum of two 12 Amp Hour batteries with the orientation illustrated in Figure 2.7. Larger batteries require a separate UL listed battery box

Note: Do not bring wiring or conduit into the bottom of the cabinet for this application.

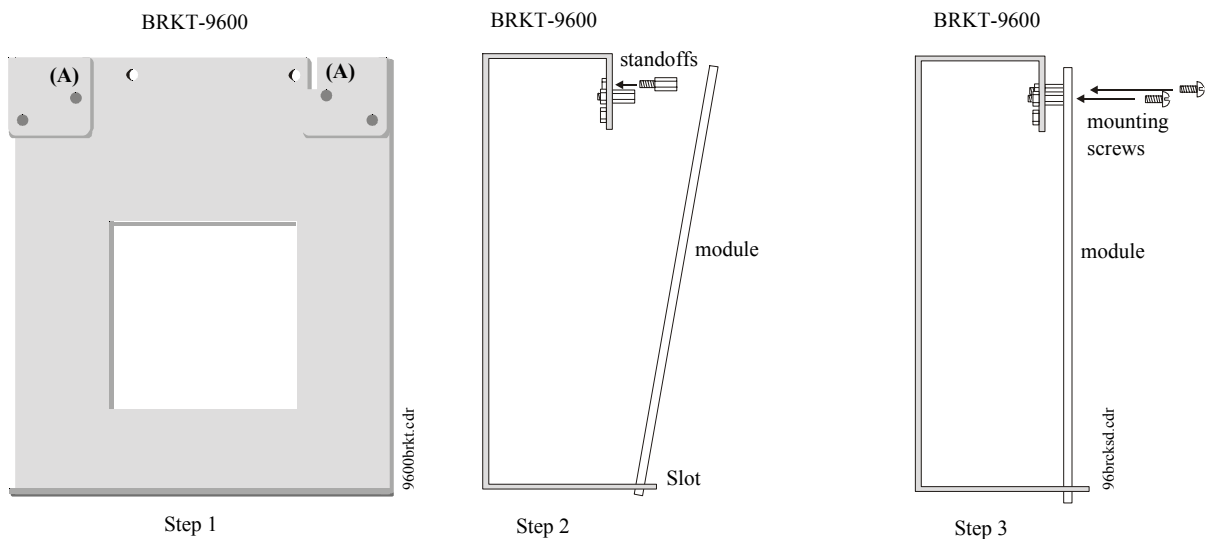

Figure 2.8 BRKT-9600 Module Installation Steps

2.9.3.3 ACM and AFM Series Annunciators

ACM and AFM Series Annunciators provide visual indications of FACP status in remote locations. Refer to the appropriate annunciator manual for information on installation, wiring and operation.

Annunciator addressing is specific to the MS-9200UD control panel. The following table describes the annunciator addresses and the corresponding addressable devices that will be annunciated at each annunciator address.

ACM Annunciator Address	Annunciator Displays the Following Points
1	8 General System Status Points & Zones 1 - 56
2	Zones 57 - 99 & 4 NACs
3	SLC Loop, Module Addresses 1 - 64
4	not used
5	SLC Loop, Module Addresses 65 - 99
6	not used
7	not used
8	SLC Loop, Detector Addresses 1 - 64
9	not used
10	SLC Loop, Detector Addresses 65 - 99
11	not used
12	not used
13	not used
14	not used
15	not used
16	not used
17	not used
18	not used
19	not used
20	8 General System Status Points & Zones 1 - 56
21	Zones 57 - 99 & 4 NACs
22	SLC Loop, Module Addresses 1 - 64
23	not used
24	SLC Loop, Module Addresses 65 - 99
25	not used
26	not used
27	SLC Loop, Detector Addresses 1 - 64
28	not used
29	SLC Loop, Detector Addresses 65 - 99
30	not used
31	not used
32	not used

The MS-9200UD must be programmed for the annunciators installed on the system. Refer to "Annunciators/UDACT" on page 98 for information on annunciator programming. Make certain to program the annunciator addresses that have been physically installed on the system.

Note: The 8 General System Status Points include the following:

- General Alarm
- General Trouble
- General Supervisory
- Alarm Silenced
- System Off Normal
- AC Loss
- Battery Fault
- NAC Fault

SECTION 3 Programming

3.1 Programming Data Entry

Programming can be accomplished using the MS-9200UD keypad or by connecting an optional standard computer keyboard. The keyboard can be connected to the PS-2 connector J3 on the control panel main circuit board.

The information presented in this section refers to programming the MS-9200UD via the onboard keypad. If an optional computer keyboard is connected to the MS-9200UD main circuit board, the following table describes the keyboard keys which correspond to the onboard keypad keys.

Keypad Keys	Computer Keyboard Keys
1st Event	Home
CLR	Delete
ESC	Esc
RECALL	Insert
*	*
#	#
A - Z	A - Z
0 - 9	0 - 9
■ (on QZ key)	Space bar
—	—
/	/
•	•
←	←
→	→
↑	↑
↓	↓
ENTER	Enter
ACK/STEP	F1
SILENCE	F2
DRILL	F3
RESET	F4

3.2 User Programming



The MS-9200UD is completely field programmable and requires no special software skills. *While programming the MS-9200UD, the fire protection capabilities of the control panel are enabled.*

Site-specific programming may be accomplished in three ways:

- **Autoprogramming Feature** - This is a convenient method for quickly bringing the FACP addressable SLC devices on-line without the necessity of programming each device individually. Refer to "Autoprogram" on page 49 for a detailed description of Autoprogramming
- Manual programming or editing, using the FACP keypad or a PC keyboard
- Off-line Programming and Editing Feature - allows creation and editing of site-specific custom programs using a Windows-based computer. For programs requiring a large amount of data entry, this method may be preferred. A PK-CD programming kit can be ordered for this purpose

The *System All Normal* screen will be displayed in a programmed system with no active alarms, troubles or supervisories, as illustrated below:



Programming, Read Status and Manual Dial mode can be entered while the panel is in any mode of operation. If the panel is in alarm, the alarm condition must be acknowledged before entering any other mode. To access any of the programming or read status features, the *Enter* or *Mode* key must be pressed, which will cause the LCD to display the following:

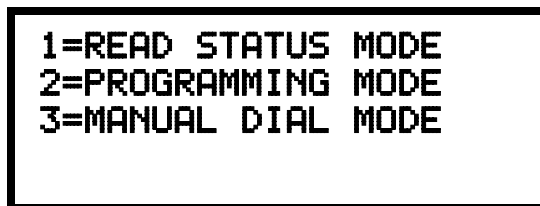

Pressing *1*, while this screen is being displayed, will cause the control panel to enter the Read Status Mode which allows the user to view the programmed features and status of the control panel. The Read Status feature is not password protected. Refer to "Read Status" on page 142 for a detailed description of this feature.



Pressing *2* will select user Programming Mode which may only be accomplished by an authorized person. After pressing *2*, a screen will prompt for a password. After entering the correct password, the user may select from a list of programming options.

Pressing *3* will select the Manual Dial Mode which allows the user to enter a troubleshoot mode of operation.

Exit Programming, Read Status and Manual Dial Mode

The programmer can exit any mode by repeatedly pressing the keypad *ESC* (Escape) key until the display reads System All Normal. *Note that the data which is entered during Programming mode is not saved until the programmer exits this mode by repeatedly pressing the 'ESC' key. If the Reset key is pressed or power is lost before exiting Programming mode, all data just entered will be lost.*

User Programming Levels

There are two user programming levels:

- User Master Program Level 1 is used for programming panel specific data relating to device types, zoning, messages, control panel functions, etc.
- User Maintenance Program Level 2 is used by a qualified operator to access features such as Disable/Enable, View and Clear History, Walktest and System Time Change.

3.3 Initial Power-up

The following sections describe the initial programming procedures for a new system. The same procedures are used to modify programming in an existing system.

After completing the wiring of addressable devices to the SLC, apply power to the control panel. If the addressable devices have not yet been programmed into the FACP, their LEDs will not flash and the following trouble message will be displayed.

```

TROUBL IN SYSTEM
NO DEVICES INSTALLED

09:03A 012102
  
```

3.4 Programming Screens Description

Three options are available when the *Enter* key is pressed: Read Status, Programming and Manual Dial Mode. The Read Status and Programming options have multiple functions or features which may be chosen. To view all of the choices, it is necessary that the programmer scroll through a number of additional *subscreens*. These selections are displayed on multiple screens to make them more readable for the programmer. Refer to "Master Programming Level" on page 48, for additional information on the various screens.



See Page

The title of the main option screen will always be displayed at the top of the subscreens for the programmer's convenience. If additional subscreens exist, an Up or Down arrow will be displayed in the upper right corner of the screen being viewed. The programmer can then press the keypad Up or Down arrow key to view the new subscreen. To select one of the choices in a screen, the programmer presses the keypad numerical key corresponding to the desired choice.

Note that subscreens may also have multiple options which require viewing more than one screen. The same process, as detailed in the previous paragraphs, is followed to view all option choices.

3.5 Programming and Passwords

There are two factory set programming passwords which will access the Programming screens as indicated in the following examples. From either of the screens, access to specific system and device features or programming may be obtained. All user programming entries are stored in nonvolatile memory. The factory set passwords can be changed by the user as described in "Password Change" on page 118. If an invalid password is entered, the blinking cursor will return to the first password character position. To exit Programming, Read Status or Manual Dial mode at any time, press the *ESC* (Escape) key repeatedly. Note that Programming mode must be exited using the *ESC* key in order to store the program data entered during this mode. If the *Reset* key is pressed or power is lost before exiting Programming mode, the data just entered will not be saved.



See Page

To access user Programming mode, press the *Enter* or *Mode* key. The LCD will display the following:



To enter the user Programming mode, press 2. The display will read as follows:



Entering the ***Master*** level password (default 0000) will cause the following screen to appear:



If the ***Maintenance*** level password (default 1111) is entered, the following screen will appear:



Note that in the two preceding screens, an arrow appears to inform the programmer that additional options can be viewed by pressing the keypad *down* arrow key.

3.6 Master Programming Level

When the Master Program Level password is entered, the control panel will enter user Programming mode. In this mode, the piezo sounder remains off, the trouble relay is activated and the system Trouble LED flashes until Programming mode is exited. The following display will appear:



Programming Screen #1

The down arrow which appears in the display indicates that additional programming choices can be viewed by pressing the down arrow key on the keypad. If a down and up arrow appear in the display, pressing the 'down' arrow key will display the subsequent Programming Screens as illustrated below while pressing the 'up' arrow key will display the previous screen.



Programming Screen #2



Programming Screen #3

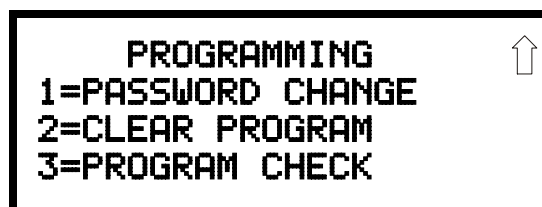

Programming Screen #4

```

PROGRAMMING
1=AUTOPROGRAM
2=POINT PROGRAM
3=ZONE SETUP

```

Programming Screen #1

3.6.1 Autoprogram

Pressing *I* while viewing Programming Screen #1, will select the Autoprogram option, which prompts the control panel to poll all devices installed on the SLC loop. The primary purpose of autoprogramming is to allow the installer a fast and easy way to bring the system on-line as quickly as possible. The first time the system is powered-up, it should be autoprogrammed.

If the system is already programmed and Autoprogram is initiated, the system will only add default values for newly installed devices.

When Autoprogram is selected, the control panel will begin autoprogramming the system by communicating with each addressable device installed on the SLC loop. While autoprogramming, the panel will display the following:

```

AUTOPROGRAM
AUTOPROGRAMMING!
PLEASE WAIT

```

Autoprogram Progress Screen

When Autoprogramming is completed, the control panel will display the type and quantity of each device installed on the SLC loop similar to the following display:

```

# OF DET LOOP1 055
# OF MON LOOP1 035
# OF CON LOOP1 030

```

Autoprogram Result Screen #1

In the preceding example, the display indicates that the SLC Loop has 55 addressable detectors, 35 monitor modules and 30 control modules installed.

Pressing the *ESC* key will return the display to Programming Screen #1.

3.6.2 Point Program

```

PROGRAMMING
1=AUTOPROGRAM
2=POINT PROGRAM
3=ZONE SETUP

```

Programming Screen #1

The Point Program option allows the programmer to add a new addressable device to an SLC loop, delete an existing device from a loop or change the programming for an existing device. Pressing 2, while viewing Programming Screen #1, will select the Point Program option and display the following screen:

```

POINT PROGRAM
SELECT TYPE
1=DETECTOR
2=MODULE

```

Point Program Screen

3.6.2.1 Detector Programming

Pressing 1, while viewing the Point Program Screen, will allow the programmer to add, delete or change the programming of an addressable detector. The following screen will be displayed by the control panel:

```

DETECTOR
1=ADD
2=DELETE
3=EDIT

```

Detector Screen

3.6.2.1.1 Add Detector

Pressing 1 while viewing the Detector Screen will display the following screen which allows the programmer to add a new detector address to programming:

```

ADD DETECTOR
ENTER DETECTOR#
***

```

Add Detector Screen

A flashing cursor will appear in the position of the first asterisk to the left. The programmer keys in the three digit detector address, such as 005.

When the last digit is keyed-in, the following screen will be displayed:

```

ADD DETECTOR
DETECTOR#      005
IS ADDED

```

The programmer can continue adding detectors by pressing the *ESC* key which will return the display to the Add Detector Screen.



Detector Screen

3.6.2.1.2 Delete Detector

Pressing 2 in the Detector Screen will display the Delete Detector Screen which allows the programmer to delete a specific detector:



Delete Detector Screen

A flashing cursor will appear in the position of the first asterisk to the left. The programmer keys in the three digit detector address, such as 005. When the last digit is keyed-in, the following screen will be displayed:



The programmer can continue deleting detectors by pressing the *ESC* key which will return the display to the Delete Detector Screen.

3.6.2.1.3 Edit Detector

The programmer can change a detectors existing or factory default programming by pressing 3 in the Detector Screen. The following screen will be displayed:



Edit Detector Screen

A flashing cursor will appear in the position of the first asterisk to the left. The programmer keys in the three digit detector address, such as 017.

When the last digit is keyed-in, if the selected address has not been added to programming, a screen showing information about a device with the *highest* address that is installed will be displayed.

If no detectors have been installed on the loop, the following will be displayed:



Edit Detector Screen #1

If the selected address has been added to programming, device summary screens will be displayed. These screens allow the programmer to view all device settings at a single glance. Pressing the left or right arrow keys will allow the programmer to rapidly view the devices at the previous or next address (if installed).

If a detector (such as a photoelectric detector) with the selected address is not physically installed on the SLC or has a communication fault but the address is programmed in the system, the following screen will be displayed:

```

TROUBL SMOKE<PHOTO>
<ADJ> <NOUN>
                ZNNN
                *  1D017
  
```

Edit Detector Screen #1

If the selected address has been added to programming and a detector (such as a photoelectric detector) with the selected address is physically installed on the SLC and is communicating with the control panel, the following will be displayed:

```

NORMAL SMOKE <PHOTO>
<ADJ> <NOUN>
                ZNNN
                V  1D017
  
```

Edit Detector Screen #1

To change the programming for the displayed detector, press the keyboard 'down' arrow key to view the Edit Detector screens.

In the preceding example:

- ✓ Normal - indicates that the detector with the selected address is physically installed on the SLC and communicating with the control panel (enabled)
- ✓ <ADJ><NOUN> - represents the adjective and noun, which have been programmed, describing the location of the displayed device
- ✓ ZNNN - represents the first of five possible software zones that the detector is assigned to (NNN = the three digit zone number from 000 - 099)
- ✓ V or * - indicates whether or not alarm verification is enabled (V = alarm verification enabled and * = alarm verification disabled)
- ✓ 1D017 - represents the Loop, Device type and Device address (1 = SLC Loop, D=Detector and 017 = Detector Address 017)

The following examples show the editing of a photoelectric smoke detector with address 017, located on the SLC loop:

```

EDIT DETECTOR 1D017
1=ENABLED      YES
2=TYPE  SMOKE(PHOTO)
3=VERIFICATION OFF
    
```

Edit Detector Screen #2

```

EDIT DETECTOR 1D017
1=WALKTEST     NO
2=PAS          NO
3=PRE-SIGNAL   NO
    
```

Edit Detector Screen #3

```

EDIT DETECTOR 1D017
1=ZONE ASSIGNMENT
  00 ** ** ** **
    
```

Edit Detector Screen #4

```

EDIT DETECTOR 1D017
1=NOUN/ADJECTIVE
2=DESCRIPTION
*****
    
```

Edit Detector Screen #5

```

EDIT DETECTOR
1=ENABLED
2=TYPE
3=VERIFICATION
    
```

Edit Detector Screen #2

Enable/Disable Detector

To Enable or Disable the detector, press the *I* key while viewing the Edit Detector Screen #2. Each press of the key will toggle the screen between *Enabled Yes* and *Enabled No*. If *Enabled No* is selected, the detector will not be polled by the control panel, preventing the detector from reporting alarms and troubles to the panel. The control panel will display the device type and address which has been disabled and will turn on the Trouble LED and Disable LED.

Type

EDIT DETECTOR
1=ENABLED
2=TYPE
3=VERIFICATION

Edit Detector Screen #2

To select the type of detector being programmed, press the 2 key while viewing the Edit Detector Screen #2. This will cause the control panel to display the following Detector Type Screens:

DETECTOR TYPE
1=SMOKE (PHOTO)
2=SMOKE (ION)
3=HEAT DETECT

Detector Type Screen #1

DETECTOR TYPE
1=SMOKE-DUCT-P
2=SUPERV DUCTP

Detector Type Screen #2

While viewing either Detector Type screen, select the type of detector being programmed by pressing the corresponding keyboard number key. The display will return to Edit Detector Screen #2 and indicate the selection next to the Type option.

Note: If a detector is selected to be a SUPERV DUCTP type, it will function like a supervisory point not a fire alarm point. The supervisory LED and supervisory relay will activate, not the fire alarm LED or alarm relay, if the detector senses smoke.

Verification

Alarm verification is used to confirm that a smoke detector activation is a true alarm condition and not a false alarm. This feature is selected by pressing 3 while viewing the Edit Detector Screen #2 so that the display reads *Verification On*. Each time the 3 key is pressed, the display will toggle between *Verification On* and *Verification Off*. For a detailed description, refer to "Alarm Verification (None or One Minute)" on page 141.



Walktest

The Walktest feature allows one person to test the system devices without the necessity of manually resetting the control panel after each device activation. To enable a device for the Walktest feature, press 1 while viewing the Edit Detector Screen #3 until the display reads *Walktest Yes*. Each press of the 1 key will cause the display to toggle between *Walktest Yes* and *Walktest No*. Refer to "Walktest" on page 141.

EDIT DETECTOR
1=WALKTEST
2=PAS
3=PRE-SIGNAL

Edit Detector Screen #3

PAS

The PAS (Positive Alarm Sequence) option will program the detector to delay panel activation (including alarm relay and communicator) for a period of 15 seconds plus a programmable time of up to 3 minutes. Zone 97, however, will activate immediately and may be used to connect a signaling device to indicate PAS activation (*do not use a Notification Appliance Circuit for this purpose*). To enable the PAS feature, press 2 while viewing the Edit Detector Screen #3 until the display reads *PAS Yes*. Each press of the 2 key will cause the display to toggle between *PAS Yes* and *PAS No*. Refer to "Positive Alarm Sequence" on page 139.



For example, if a detector with address 005 is to be configured for PAS operation:

- ✓ Select *PAS Yes* when editing the detector set to address 005
- ✓ Program the desired zone or zones to be activated by this detector, in this example Z001
- ✓ Program an output, such as a control module that is to be activated by detector 005 by assigning the same zone to it; in this example Z001
- ✓ Program an output, such as a control module, for PAS activation by assigning zone Z97 to it. This control module may be connected to a signaling device used to indicate a PAS condition (*do not use a Notification Appliance Circuit for this purpose*)
- ✓ Enable zones Z001 and Special Purpose Zone PAS 97 and set the PAS delay timer to some value

With the preceding program settings, when the detector with address 005 is activated, zone Z97 will cause its associated control module to activate immediately, sounding the connected PAS signaling device. Following the PAS delay time, zone Z001 will cause its associated control module to activate and the control panel will initiate an alarm condition.

Pre-signal

EDIT DETECTOR 1=WALKTEST 2=PAS 3=PRE-SIGNAL
--

Edit Detector Screen #3



The Pre-signal option programs the detector to delay panel activation for a preprogrammed time delay of up to three minutes while allowing for visual verification by a person. Note that the alarm relay and communicator will respond to the initial alarm immediately. In addition, Zone 98 will activate. This zone can be programmed to a control module which may be used to activate a sounder or indicator which the installer designates as a Presignal indication (*do not use a Notification Appliance Circuit for this purpose*). To enable the Pre-signal feature, press 3 while viewing Edit Detector Screen #3 until the display reads *Pre-signal Yes*. Each press of the 3 key will cause the display to toggle between *Pre-signal Yes* and *Pre-signal No*. Refer to "Presignal" on page 138.

For example, if a detector with address 005 is to be configured for Pre-Signal operation:

- ✓ Select *Pre-signal Yes* when editing the detector set to address 005
- ✓ Program the desired zone or zones to be activated by this detector, in this example Z001
- ✓ Program an output, such as a control module that is to be activated by detector 005 by assigning the same zone to it; in this example Z001
- ✓ Program an output, such as a control module, for Pre-signal activation by assigning zone Z98 to it. This control module may be connected to a signaling device used to indicate a Pre-signal condition (*do not use a Notification Appliance Circuit for this purpose*)
- ✓ Enable zones Z001 and Special Purpose Zone Pre-signal 98 and set the Pre-signal delay timer to some value

With the preceding program settings, when the detector with address 005 is activated, zone Z98 will cause its associated control module to activate immediately, sounding the connected signaling device to indicate the Pre-signal condition. Following the Pre-signal delay time, zone Z001 will cause its associated control module to activate and the control panel will initiate an alarm condition.

Zone Assignment

A maximum of five zones can be programmed to each addressable detector. Pressing *I* while viewing Edit Detector Screen #4 displays the following screen:

```

EDIT DETECTOR
1=ZONE ASSIGNMENT
00 ** ** ** **

```

Edit Detector Screen #4

```

ZONE ASSIGNMENT
Z00 Z** Z** Z** Z**

```

Zone Assignment Screen

Note that Z** represents the Zone Number(s) corresponding to this device. The factory default for an unprogrammed device is Z00 for general alarm zone. A flashing cursor will appear on the first 0 to the left. Enter the two digit number corresponding to the zone that is to be assigned to this device. The cursor moves to the next Z** designation. Continue entering zone assignments or the remaining zones can be left blank or programmed as general alarm zone Z00. When all desired changes have been made, press the Enter key to store the zone assignments. The display will return to the Edit Detector Screen #4. Note that the left and right arrow keys can be used to navigate through the zones and the CLEAR key can be used to quickly clear a zone.



Noun/Adjective

The Noun/Adjective selection allows the programmer to enter specific descriptors about the detector currently being programmed. Pressing *I* while viewing Edit Detector Screen #5 will cause the following screen to be displayed:

```

EDIT DETECTOR
1=NOUN/ADJECTIVE
2=DESCRIPTION
*****

```

Edit Detector Screen #5

```

1=STANDARD ADJECTIVE
2=STANDARD NOUN
3=CUSTOM ADJECTIVE
4=CUSTOM NOUN

```

Noun/Adjective Screen

```

1=STANDARD ADJECTIVE
2=STANDARD NOUN
3=CUSTOM ADJECTIVE
4=CUSTOM NOUN

```

Noun/Adjective Screen

Pressing 1 while viewing the Noun/Adjective Screen will cause the following screen(s) to be displayed. Note that the keyboard *down* arrow key must be pressed to see all the Adjective screens. Press the number corresponding to the adjective that is to be used as a descriptor for the location of the detector currently being programmed. When an adjective has been selected, it will appear at the top of the display as indicated by the asterisks.

```

*****
1=NORTH
2=SOUTH
3=EAST

```

Adjective Screen #1

```

*****
1=3RD
2=4TH
3=5TH

```

Adjective Screen #5

```

*****
1=WEST
2=FRONT
3=CENTER

```

Adjective Screen #2

```

*****
1=FLOOR1
2=FLOOR2
3=FLOOR3

```

Adjective Screen #6

```

*****
1=REAR
2=UPPER
3=LOWER

```

Adjective Screen #3

```

*****
1=FLOOR4
2=FLOOR5
3=ROOM

```

Adjective Screen #7

```

*****
1=MAIN
2=FIRST
3=2ND

```

Adjective Screen #4

```

1=STANDARD ADJECTIVE
2=STANDARD NOUN
3=CUSTOM ADJECTIVE
4=CUSTOM NOUN

```

Noun/Adjective Screen

Pressing 2 while viewing the Noun/Adjective Screen will cause the following screen(s) to be displayed. Note that the keyboard *down* arrow key must be pressed to see all the Noun screens. Press the number corresponding to the noun that is to be used as a descriptor for the location of the detector currently being programmed. When a noun has been selected, it will appear at the top of the display as indicated by the asterisks.

```

*****
1=BASEMENT
2=BOILER RM
3=CLASSROOM

```

Noun Screen #1

```

*****
1=KITCHEN
2=LOBBY
3=OFFICE

```

Noun Screen #5

```

*****
1=CLOSET
2=CORRIDOR
3=ELECTRIC RM

```

Noun Screen #2

```

*****
1=PATIENT
2=RESTROOM
3=ROOM

```

Noun Screen #6

```

*****
1=ELEVATOR
2=ENTRANCE
3=FLOOR

```

Noun Screen #3

```

*****
1=STAIRWAY
2=STOREROOM
3=WING

```

Noun Screen #7

```

*****
1=GARAGE
2=HALLWAY
3=HVAC RM

```

Noun Screen #4

```

*****
1=ZONE

```

Noun Screen #8

```

1=STANDARD ADJECTIVE
2=STANDARD NOUN
3=CUSTOM ADJECTIVE
4=CUSTOM NOUN
    
```

Noun/Adjective Screen

```

EDIT DETECTOR
1=NOUN/ADJECTIVE
2=DESCRIPTION
    
```

Edit Detector Screen #5

Pressing 3 or 4 while viewing the Noun/Adjective Screen will display screens similar to the previous Adjective and Noun Screens. The new screens will list custom Adjectives and Nouns which have been programmed into the control panel using the PK-CD programming kit. These descriptors are selected as described in the previous sections.

Description

The Description selection allows the programmer to enter additional information about the detector currently being programmed. This information will be displayed as part of the device label on the display. Pressing 2 while viewing Edit Detector Screen #5 will cause the following screen to be displayed:

```

DESCRIPTION      1D002
1=NOUN/ADJECTIVE

*****
    
```

Adjective/Noun Screen

A flashing cursor will appear at the first asterisk to the left. The programmer can enter additional descriptive information about the device being programmed. This information will appear on the display along with the standard device label information.

A maximum of 20 characters (including spaces) can be entered. To enter alphanumeric characters from the keypad, repeatedly press the appropriate key until the desired character is displayed in the first position. For example, to enter the letter *B*, press the 2 (ABC) key three times to toggle through the characters *I*, *A* and *B*. Press the right arrow key to move the cursor one position to the right and repeat the process to enter the next character. To enter a space, press the * (QZ) key four times until a blank appears in the desired position. When all characters have been entered, press the Enter key to store the information. The display will return to the Edit Detector Screen #5, displaying the new information at the bottom of the screen.

Recall/Increment Function

In addition, the user may use the Recall/Increment function at any time when the cursor is on the first letter of the Description, Adjective or Noun field as follows:

- If the zero key is pressed, a 0 is placed in the first letter position
- If the zero key is then pressed a second time with no intervening key actions, the entire field is replaced with the field entered *for the previous device programmed*, and the cursor moves to the last character of the field (Recall function). The Recalled Adjective or Noun field may now be changed letter-by-letter
- If the zero key is pressed again with no other intervening key actions and the last character in the field is a number 0-9, the number is incremented by one. If the last character is a letter, it changes to a 0. If the last character goes from 9 to 0 and the characters to the left of the last character are also numbers, they are also incremented (overflow)
- The above increment function may be repeated with each press of the zero key

As an example, the user could quickly enter 'FLR_3_ROOM_305' as follows:

1. The cursor is on the first letter of the Adjective field. Press the zero key twice to display *FLR_3*
2. With the cursor on the first letter of the Noun field, press the zero key twice to recall the display *ROOM_304*. The cursor automatically jumps from the first to the last letter of the Noun field
3. With the cursor on the last letter of the Noun field, press the zero key again to increment the room number to *305*
4. Press the right arrow key to advance the zone field
5. Select a zone number from 00 to 99. Z00 (default zone) is the general alarm zone. Z01 through Z99 may be selected to link software zones

3.6.2.2 Module Programming

Pressing 2, while viewing Point Program Screen #2, will allow the programmer to add, delete or change the programming of an addressable module. The following screen will be displayed by the control panel:

```
POINT PROGRAM
SELECT TYPE
1=DETECTOR
2=MODULE
```

Point Program Screen #2

```
MODULES
1=ADD
2=DELETE
3=EDIT
```

Modules Screen

3.6.2.2.1 Add Module

Pressing 1 while viewing the Modules Screen will display the following screen which allows the programmer to add a new module address to programming:

```
ADD MODULE
ENTER MODULE#
***
```

Add Module Screen #1

A flashing cursor will appear in the position of the first asterisk to the left. The programmer keys in the three digit module address, such as *005*.

When the last digit is keyed-in, the following screen will be displayed:

```
ADD MODULE
1=CONTROL
2=MONITOR
```

Add Module Screen #2

Pressing 1 for Control Module or 2 for Monitor Module will cause the following

screen to be displayed:

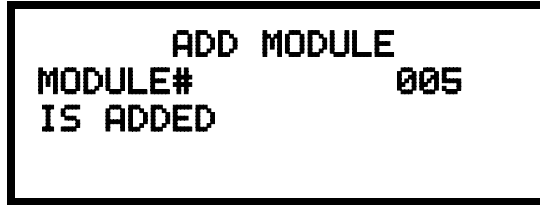

Add Module Screen #3

The programmer can continue adding modules by pressing the *ESC* or left arrow key which will return the display to the Add Module Screen #1.

3.6.2.2.2 Delete Module

Pressing 2 in the Modules Screen will display the Delete Module Screen which allows the programmer to delete a specific module:



Modules Screen

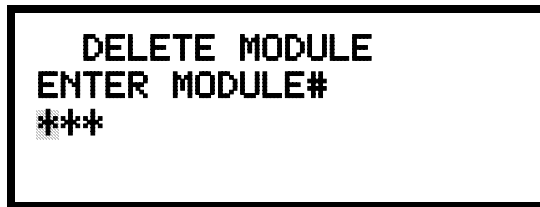

Delete Module Screen

A flashing cursor will appear in the position of the first asterisk to the left. Using the panel keypad, key in the module address such as 005. When the last digit is keyed in, the following confirmation that the module has been deleted will be displayed:

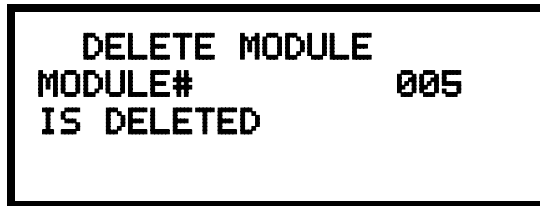

3.6.2.2.3 Edit Module Screen for Monitor Module

The programmer can change a modules existing or factory default programming by pressing 3 in the Modules Screen. The following screen will be displayed:

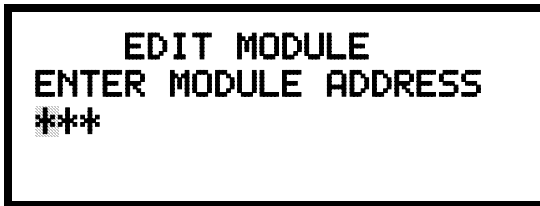

Edit Module Screen

A flashing cursor will appear in the position of the first asterisk to the left. The

programmer keys in the three digit module address, such as 012. When the last digit is keyed-in, if the selected address has not been added to programming, a screen showing information about the highest address that is installed will be displayed. If no modules are installed on the loop, the following screen will be displayed:

```

NO MODULE
INSTALLED

```

Edit Module Screen

If the selected address has been added to programming but a module (such as a monitor module) with the selected address is not physically installed on the SLC or has a communication fault, the following screen will be displayed:

```

TROUBL MONITOR
<ADJ> <NOUN>
      ZNNN
*    1M012

```

If the selected address has been added to programming and a module (such as a monitor module) with the selected address is physically installed on the SLC and is communicating with the control panel, the following screen will be displayed:

```

NORMAL MONITOR
<ADJ> <NOUN>
      ZNNN
W    1M012

```

To change the programming for the displayed module, press the keyboard down arrow key to view the following Edit Monitor screens. In the preceding example:

- ✓ Normal - indicates that the module with the selected address is physically installed on the SLC and communicating with the control panel (enabled)
- ✓ <ADJ><NOUN> - represents the adjective and noun, which have been programmed, describing the location of the displayed device
- ✓ ZNNN - represents the first of five possible software zones that the module is assigned to (NNN = the two digit zone number from 000 - 099)
- ✓ 1M012 - represents the Loop, Device type and Device address (1 = SLC Loop 1, M=Module and 012 = Module Address 012)
- ✓ W or * - indicates whether or not the device is programmed for Walktest (W = programmed for walktest, * = not programmed for walktest).



If the selected address corresponds to a control module, a screen displaying information about the control module with the selected address will be displayed as shown in "Edit Module Screen for Control Modules" on page 70.

If the selected address corresponds to a monitor module, a screen displaying information about the module with the selected address will be displayed as illustrated in the following:

```

NORMAL MONITOR
  <ADJ> <NOUN>
                ZNNN
                1M012
  
```

```

EDIT MONITOR  1M012
1=ENABLED      YES
2=TYPE  MONITOR
  
```

Edit Monitor Screen #2

```

EDIT MONITOR  1M012
1=PRE-SIGNAL   NO
2=PAS          NO
  
```

Edit Monitor Screen #3

```

EDIT MONITOR  1M012
1=WALKTEST    YES
2=ZONE ASSIGNMENT
  00 ** ** ** **
  
```

Edit Monitor Screen #4

```

EDIT MONITOR  1M012
1=ADJECTIVE/NOUN
2=DESCRIPTION
*****
  
```

Edit Monitor Screen #5

Enable/Disable Module

To Enable or Disable the monitor module, press the 1 key while viewing the Edit Module Screen #2. Each press of the key will toggle the screen between *Enabled Yes* and *Enabled No*. If *Enabled No* is selected, the module will not be polled by the control panel, preventing the module from reporting alarms and troubles to the panel. The control panel will indicate a system trouble condition and the Disable LED with turn on if any devices are disabled.

```

EDIT MONITOR
1=ENABLED
2=TYPE MONITOR
    
```

Edit Monitor Screen #2

Type Monitor

Using the PK-CD Upload/Download utility program, unique user-defined monitor types can be created and loaded into the FACP for later use. The FACP response to the activation of a user-defined type is the same as most previous standard types in the list, thus allowing a variety of user-defined types and responses. To select the type of monitor module being programmed, press the 2 key while viewing the Edit Monitor Screen #2. This will cause the control panel to display the following Monitor Type Screens:

```

MONITOR TYPE
1=PULL-STATION
2=USER-DEFINED-1
3=WATERFLOW
    
```

Monitor Type Screen #1

```

MONITOR TYPE
1=USER-DEFINED-6
2=MEDIC-ALERT
3=USER-DEFINED-7
    
```

Monitor Type Screen #5

```

MONITOR TYPE
1=USER-DEFINED-2
2=MONITOR
3=BLANK
    
```

Monitor Type Screen #2

```

MONITOR TYPE
1=HAZARD-ALERT
2=USER-DEFINED-8
3=TORNADO-ALERT
    
```

Monitor Type Screen #6

```

MONITOR TYPE
1=USER-DEFINED-3
2=FUTURE USE
3=USER-DEFINED-4
    
```

Monitor Type Screen #3

```

MONITOR TYPE
1=USER-DEFINED-9
2=USER-DEFINED-10
3=USER-DEFINED-11
    
```

Monitor Type Screen #7

```

MONITOR TYPE
1=SMOKE-CONVENTIONAL
2=HEAT-DETECTOR
3=USER-DEFINED-5
    
```

Monitor Type Screen #4

```

MONITOR TYPE
1=TAMPER
2=SUPERVISORY
3=SUPERVISORY-AR
    
```

Monitor Type Screen #8

Note: For the SUPERVISORY-AR selection, AR refers to AutoResettable

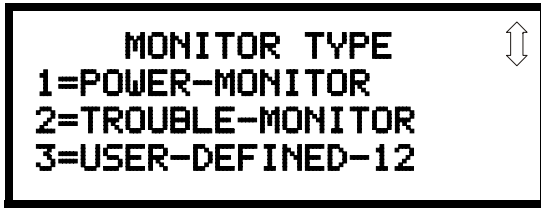

Monitor Type Screen #9

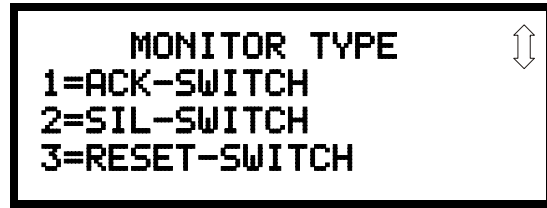

Monitor Type Screen #11

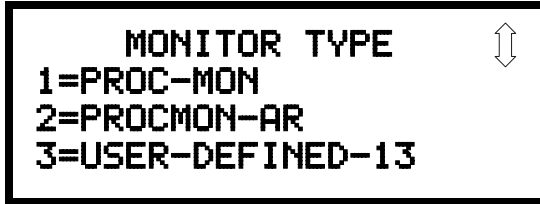

Monitor Type Screen #10

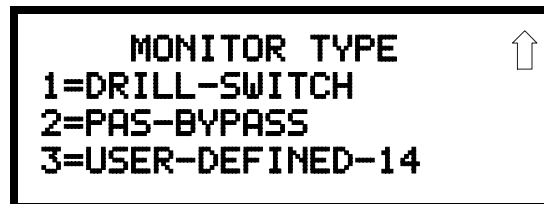

Monitor Type Screen #12

Note: For the PROCMON-AR selection, PROCMON refers to Process Monitor and AR refers to AutoResettable

While viewing one of the Monitor Type screens, select the type of monitor module being programmed by pressing the corresponding keypad number key. The display will return to the Edit Monitor Screen #2 which will show the new type selection.

Monitor module type selection will affect the function of the point as follows:

Monitor Type	Action When Activated
Pull-Station	Fire Alarm
User-Defined-1	Fire Alarm
Waterflow	Fire Alarm Delayed (uses waterflow delay)
User-Defined-2	Fire Alarm Delayed (uses waterflow delay)
Monitor	Fire Alarm
Blank	Fire Alarm
User-Defined-3	Fire Alarm
Future Use	Future Use
User-Defined-4	Supervisory on partial short, Fire Alarm on full short
Smoke-Conventional	Fire Alarm
Heat-Detector	Fire Alarm
User-Defined-5	Fire Alarm
User-Defined-6	Fire Alarm
Medic-Alert	Supervisory, latching
User-Defined-7	Supervisory, latching
Hazard-Alert	Supervisory, latching
User-Defined-8	Supervisory, latching
Tornado-Alert	Supervisory, latching
User-Defined-9	Supervisory, latching
User-Defined-10	Supervisory, latching
User-Defined-11	Supervisory, latching
Tamper	Supervisory, nonlatching (tracking)
Supervisory	Supervisory, latching
Supervisory-AR	Supervisory, nonlatching (tracking)
Power-Monitor	AC Fault
Trouble-Monitor	Trouble
User-Defined-12	Trouble
Proc-Mon	Piezo
Procmon-Auto	Piezo, nonlatching (tracking)
User-Defined-13	Piezo, nonlatching (tracking)
Ack-Switch	Acts like panel Acknowledge Key
Sil-Switch	Acts like panel Alarm Silence Key
Reset-Switch	Acts like panel Reset Key
Drill-Switch	Acts like panel Drill Key
PAS-Bypass	PAS Disable
User-Defined-14	PAS Disable

```

EDIT MONITOR
1=PRE-SIGNAL
2=PAS
    
```

Edit Monitor Screen #3



```

EDIT MONITOR
1=WALKTEST
2=ZONE ASSIGNMENT
  00 ** ** ** **
    
```

Edit Monitor Screen #4

```

EDIT MONITOR
1=NOUN/ADJECTIVE
2=DESCRIPTION
*****
    
```

Edit Monitor Screen #5

Pre-signal

To enable the Pre-signal feature, press *1* while viewing Edit Monitor Screen #3 until the display reads *Pre-signal Yes*. Each press of the *1* key will cause the display to toggle between *Pre-signal Yes* and *Pre-signal No*. Refer to "Presignal" on page 138 for additional information.

PAS

To enable the PAS feature, press *2* while viewing the Edit Detector Screen #3 until the display reads *PAS Yes*. Each press of the *2* key will cause the display to toggle between *PAS Yes* and *PAS No*. Refer to "Positive Alarm Sequence" on page 139 for additional information.

Walktest

The Walktest feature allows one person to test the system devices without the necessity of manually resetting the control panel after each device activation. To enable devices, which are connected to a monitor module, for the Walktest feature, press *1* while viewing the Edit Monitor Screen #4 until the display reads *Walktest Yes*. Each press of the *1* key will cause the display to toggle between *Walktest Yes* and *Walktest No*. Refer to "Walktest" on page 141 for additional information.

Zone Assignment

A maximum of five zones can be programmed to each addressable monitor module. Pressing *2* while viewing Edit Monitor Screen #4 displays the following screen:

```

MON ZONE ASSIGN
Z00 Z** Z** Z** Z**
    
```

Zone Assignment Screen

Note that *Z*** represents the Zone Number(s) corresponding to this device. The factory default for an unprogrammed device is *Z00* for general alarm zone. A flashing cursor will appear on the first *0* to the left. Enter the two digit number corresponding to the zone that is to be assigned to this device. The cursor moves to the next *Z*** designation. Continue entering zone assignments or the remaining zones can be left blank or programmed as general alarm zones *Z00*. When all desired changes have been made, press the Enter key to store the zone assignments. The display will return to the Edit Monitor Screen #4.

Noun/Adjective

The Noun/Adjective selection allows the programmer to enter specific descriptors about the monitor module currently being programmed. Pressing *1* while viewing Edit Monitor Screen #5 will cause the following screen to be displayed:

```

1=STANDARD ADJECTIVE
2=STANDARD NOUN
3=CUSTOM ADJECTIVE
4=CUSTOM NOUN
    
```

Noun/Adjective Screen

```

1=STANDARD ADJECTIVE
2=STANDARD NOUN
3=CUSTOM ADJECTIVE
4=CUSTOM NOUN

```

Noun/Adjective Screen

Pressing 1 while viewing the Noun/Adjective Screen will cause the following screen(s) to be displayed. Note that the keyboard *down* arrow key must be pressed to see all the Adjective screens. Press the number corresponding to the adjective that is to be used as a descriptor for the location of the monitor module currently being programmed.

```

*****
1=NORTH
2=SOUTH
3=EAST

```

Adjective Screen #1

```

*****
1=3RD
2=4TH
3=5TH

```

Adjective Screen #5

```

*****
1=WEST
2=FRONT
3=CENTER

```

Adjective Screen #2

```

*****
1=FLOOR 1
2=FLOOR 2
3=FLOOR 3

```

Adjective Screen #6

```

*****
1=REAR
2=UPPER
3=LOWER

```

Adjective Screen #3

```

*****
1=FLOOR 4
2=FLOOR 5
3=ROOM

```

Adjective Screen #7

```

*****
1=MAIN
2=FIRST
3=2ND

```

Adjective Screen #4

```

1=STANDARD ADJECTIVE
2=STANDARD NOUN
3=CUSTOM ADJECTIVE
4=CUSTOM NOUN

```

Noun/Adjective Screen

Pressing 2 while viewing the Noun/Adjective Screen will cause the following screen(s) to be displayed. Note that the keyboard *down* arrow key must be pressed to see all the Noun screens. Press the number corresponding to the noun that is to be used as a descriptor for the location of the monitor module currently being programmed.

```

*****
1=BASEMENT
2=BOILER RM
3=CLASSROOM

```

Noun Screen #1

```

*****
1=KITCHEN
2=LOBBY
3=OFFICE

```

Noun Screen #5

```

*****
1=CLOSET
2=CORRIDOR
3=ELECTRIC RM

```

Noun Screen #2

```

*****
1=PATIENT
2=RESTROOM
3=ROOM

```

Noun Screen #6

```

*****
1=ELEVATOR
2=ENTRANCE
3=FLOOR

```

Noun Screen #3

```

*****
1=STAIRWAY
2=STOREROOM
3=WING

```

Noun Screen #7

```

*****
1=GARAGE
2=HALLWAY
3=HVAC RM

```

Noun Screen #4

```

*****
1=ZONE

```

Noun Screen #8

Pressing 3 or 4 while viewing the Noun/Adjective Screen will display screens similar to the previous Adjective and Noun Screens. The new screens will list Custom Adjectives and Nouns which have been programmed into the control panel using the PK-CD programming kit.



Description

The Description selection allows the programmer to enter additional information about the monitor module currently being programmed. This information will be displayed as part of the device label on the LCD display. Pressing 2 while viewing Edit Monitor Screen #5 will cause the following screen to be displayed:



Noun/Adjective Screen

A flashing cursor will appear at the first asterisk to the left. The programmer can enter additional descriptive information about the device being programmed. This information will appear on the LCD display along with the standard device label information.

A maximum of 20 characters (including spaces) can be entered. To enter alphanumeric characters from the keypad, repeatedly press the appropriate key until the desired character is displayed in the first position. For example, to enter the letter *B*, press the 2 (*ABC*) key three times to toggle through the characters 2, *A* and *B*. Press the right arrow key to move the cursor one position to the right and repeat the process to enter the next character. To enter a space, press the * (*QZ*) key four times until a blank appears in the desired position. When all characters have been entered, press the Enter key to store the information. The display will return to the Edit Monitor Screen #4, displaying the new information at the bottom of the screen.

Recall/Increment Function

In addition, the user may use the Recall/Increment function at any time when the cursor is on the first letter of the Adjective or Noun field as follows:

- If the zero key is pressed, a 0 is placed in the first letter position
- If the zero key is then pressed a second time with no intervening key actions, the entire Adjective field is replaced with the field entered for the previous device programmed, and the cursor moves to the last character of the field (Recall function). The Recalled Adjective or Noun field may now be changed letter-by-letter
- If the zero key is pressed again with no other intervening key actions and the last character in the field is a number 0-9, the number is incremented by one. If the last character is a letter, it changes to a 0. If the last character goes from 9 to 0 and the characters to the left of the last character are also numbers, they are also incremented (overflow)
- The above increment function may be repeated with each press of the zero key

As an example, the user could quickly enter 'FLR_3_ROOM 305' as follows:

1. The cursor is on the first letter of the Adjective field. Press the zero key twice to display *FLR_3*
2. With the cursor on the first letter of the Noun field, press the zero key twice to recall the display *ROOM_304*. The cursor automatically jumps from the first to the last letter of the Noun field
3. With the cursor on the last letter of the Noun field, press the zero key again to increment the room number to *305*
4. Press the right arrow key to advance the zone field
5. Select a zone number from 00 to 99. Z00 (default zone) is the general alarm zone. Z01 through Z99 may be selected to link software zones

3.6.2.2.4 Edit Module Screen for Control Modules

The programmer can change a module's existing or factory default programming by pressing 3 in the Modules Screen. The following screen will be displayed:

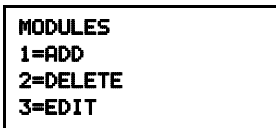

Modules Screen

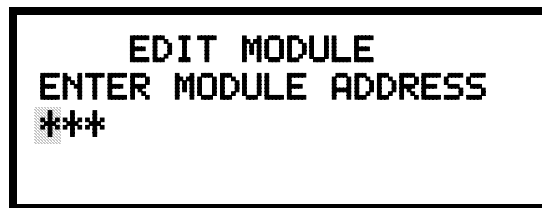

Edit Module Screen

A flashing cursor will appear in the position of the first asterisk to the left.

The programmer keys in the three digit module address, such as *002*. When the last digit is keyed-in, if the selected address corresponds to a *control* module, a screen displaying information about the control module with the selected address will be displayed as illustrated in the following:

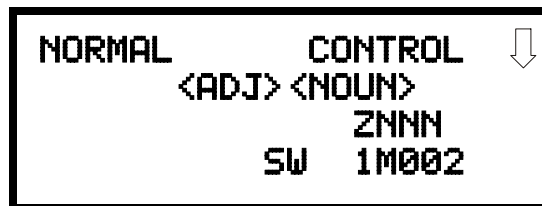

Edit Control Screen #1

In the preceding example:

- ✓ Normal - indicates that the module with the selected address is physically installed on the SLC and communicating with the control panel (enabled)
- ✓ <ADJ><NOUN> - represents the adjective and noun, which have been programmed, describing the location of the displayed device
- ✓ Control - indicates that the selected module is a control module
- ✓ S or * - represents Silenceable (S) or Nonsilenceable (*)
- ✓ W or * - represents Waterflow Timer Delay (W = Waterflow Timer Delay enabled, * = Waterflow Timer Delay disabled)
- ✓ ZNNN - represents the first of five possible software zones that the module is assigned to (NNN = the three digit zone number from 000 - 099)
- ✓ 1M002 - represents the Loop, Device type and Device address (1 = SLC Loop, M=Module and 002 = Module Address 02)

To change the programming for the displayed module, press the keyboard *down* arrow key to view the following Edit Control screens:



Edit Control Screen #2

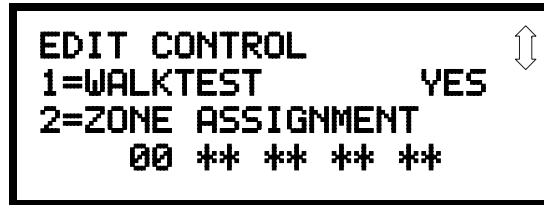

Edit Control Screen #3



Edit Control Screen #4

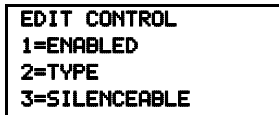

Edit Control Screen #2

Enable/Disable Module

To Enable or Disable the control module, press the *1* key while viewing the Edit Control Screen #2. Each press of the key will toggle the screen between *Enabled Yes* and *Enabled No*. If *Enabled No* is selected, the module will not be polled by the control panel, preventing the module from activating its output devices. The control panel will indicate a system trouble condition and the Disable LED will turn on if any devices are disabled.

EDIT CONTROL
1=ENABLED
2=TYPE
3=SILENCEABLE
 Edit Control Screen #2

Type

To select the type of control module being programmed, press the 2 key while viewing the Edit Control Screen #2. This will cause the control panel to display the following Control Type Screens:

CONTROL TYPE 
1=BLANK
2=BELL-CIRCUIT
3=HORN-CIRCUIT

Control Type Screen #1

CONTROL TYPE 
1=SOUNDERS
2=RELAY-1FC
3=STROBE-CKT

Control Type Screen #2

CONTROL TYPE 
1=CONTROL
2=RESETTABLE POWER

Control Type Screen #3

While viewing one of the Control Type screens, select the type of control module being programmed by pressing the corresponding keypad number key. The display will return to the Edit Control Screen #2 and indicate the new type selection.

Note: A control module set to the Resettable Power type will follow the main circuit board 24 VDC resettable power unless the control module is disabled.

The following table contains control module type codes and their functions:

Control Type	Special Function
Blank	None
Bell Circuit	None
Horn Circuit	None
Sounders	None
Relay	Ignore Open Circuit
Strobe Circuit	None
Control	None
Resettable Power	Relay Type - Ignore Open Circuit

```

EDIT CONTROL
1=ENABLED
2=TYPE
3=SILENCEABLE
    
```

Edit Control Screen #2

Silenceable

The Silenceable selection allows the programmer to select whether output devices connected to the control module can be silenced, either by pressing the Alarm Silence key or by enabling Autosilence. Pressing the 3 key while viewing Edit Control Screen #2 will enable the Silenceable feature causing the display to read *Silenceable Yes*. Repeated presses of the 3 key will cause the display to toggle between *Silenceable Yes* and *Silenceable No*.

```

EDIT CONTROL
1=WALKTEST
2=ZONE ASSIGNMENT
  00 ** ** ** **
    
```

Edit Control Screen #3

Walktest

The Walktest feature allows one person to test the system devices without the necessity of manually resetting the control panel after each device activation. To enable devices, which are connected to a control module, for the Walktest feature, press 1 while viewing the Edit Control Screen #3 until the display reads *Walktest Yes*. Each press of the 1 key will cause the display to toggle between *Walktest Yes* and *Walktest No*. Refer to "Walktest" on page 141 for additional information.

Zone Assignment

A maximum of five zones can be programmed to each addressable control module. Pressing 2 while viewing Edit Control Screen #3 displays the following screen:

```

          ZONE ASSIGNMENT
        Z00 Z** Z** Z** Z**
    
```

Zone Assignment Screen

Note that Z** represents the Zone Number(s) corresponding to this device. The factory default for an unprogrammed device is Z00 for general alarm zone. A flashing cursor will appear on the first 0 to the left. Enter the two digit number corresponding to the zone that is to be assigned to this device. The cursor moves to the next Z** designation. Continue entering zone assignments or the remaining zones can be left blank or programmed as general alarm zones Z00. When all desired changes have been made, press the Enter key to store the zone assignments. The display will return to the Edit Control Screen #3.

```

EDIT CONTROL
1=NOUN/ADJECTIVE
2=DESCRIPTION
    
```

Edit Control Screen #4

Noun/Adjective

The Noun/Adjective selection allows the programmer to enter specific descriptors about the control module currently being programmed. Pressing 1 while viewing Edit Control Screen #4 will cause the following screen to be displayed:

```

1=STANDARD ADJECTIVE
2=STANDARD NOUN
3=CUSTOM ADJECTIVE
4=CUSTOM NOUN
    
```

Noun/Adjective Screen

```

1=STANDARD ADJECTIVE
2=STANDARD NOUN
3=CUSTOM ADJECTIVE
4=CUSTOM NOUN

```

Noun/Adjective Screen

Pressing 1 while viewing the Noun/Adjective Screen will cause the following screen(s) to be displayed. Note that the keyboard *down* arrow key must be pressed to see all the Adjective screens. Press the number corresponding to the adjective that is to be used as a descriptor for the location of the control module currently being programmed.

```

*****
1=NORTH
2=SOUTH
3=EAST

```

Adjective Screen #1

```

*****
1=3RD
2=4TH
3=5TH

```

Adjective Screen #5

```

*****
1=WEST
2=FRONT
3=CENTER

```

Adjective Screen #2

```

*****
1=FLOOR 1
2=FLOOR 2
3=FLOOR 3

```

Adjective Screen #6

```

*****
1=REAR
2=UPPER
3=LOWER

```

Adjective Screen #3

```

*****
1=FLOOR 4
2=FLOOR 5
3=ROOM

```

Adjective Screen #7

```

*****
1=MAIN
2=FIRST
3=2ND

```

Adjective Screen #4

```

1=STANDARD ADJECTIVE
2=STANDARD NOUN
3=CUSTOM ADJECTIVE
4=CUSTOM NOUN

```

Noun/Adjective Screen

Pressing 2 while viewing the Noun/Adjective Screen will cause the following screen(s) to be displayed. Note that the keyboard *down* arrow key must be pressed to see all the Noun screens. Press the number corresponding to the noun that is to be used as a descriptor for the location of the control module currently being programmed.

```

*****
1=BASEMENT
2=BOILER RM
3=CLASSROOM

```

Noun Screen #1

```

*****
1=KITCHEN
2=LOBBY
3=OFFICE

```

Noun Screen #5

```

*****
1=CLOSET
2=CORRIDOR
3=ELECTRIC RM

```

Noun Screen #2

```

*****
1=PATIENT
2=RESTROOM
3=ROOM

```

Noun Screen #6

```

*****
1=ELEVATOR
2=ENTRANCE
3=FLOOR

```

Noun Screen #3

```

*****
1=STAIRWAY
2=STOREROOM
3=WING

```

Noun Screen #7

```

*****
1=GARAGE
2=HALLWAY
3=HVAC RM

```

Noun Screen #4

```

*****
1=ZONE

```

Noun Screen #8

Pressing 3 or 4 while viewing the Noun/Adjective Screen will display screens similar to the previous Adjective and Noun Screens. The new screens will list Custom Adjectives and Nouns which have been programmed into the control panel using the PK-CD programming kit.

```

EDIT CONTROL
1=ADJECTIVE/NOUN
2=DESCRIPTION

```

Edit Control Screen #4

Description

The Description selection allows the programmer to enter additional information about the control module currently being programmed. This information will be displayed as part of the device label on the display. Pressing 2 while viewing Edit Control Screen #4 will cause the following screen to be displayed:

```

DESCRIPTION      1M002
1=NOUN/ADJECTIVE

*****

```

Adjective/Noun Screen

A flashing cursor will appear at the first asterisk to the left. The programmer can enter additional descriptive information about the device being programmed. This information will appear on the display along with the standard device label information.

A maximum of 20 characters (including spaces) can be entered. To enter alphanumeric characters from the keypad, repeatedly press the appropriate key until the desired character is displayed in the first position. For example, to enter the letter *B*, press the 2 (*ABC*) key three times to toggle through the characters *I*, *A* and *B*. Press the right arrow key to move the cursor one position to the right and repeat the process to enter the next character. To enter a space, press the * (*QZ*) key four times until a blank appears in the desired position. When all characters have been entered, press the Enter key to store the information. The display will return to the Edit Control Screen #4, displaying the new information at the bottom of the screen.

Recall/Increment Function

In addition, the user may use the Recall/Increment function at any time when the cursor is on the first letter of the Adjective or Noun field as follows:

- If the zero key is pressed, a 0 is placed in the first letter position
- If the zero key is then pressed a second time with no intervening key actions, the entire Adjective field is replaced with the field entered for the previous device programmed, and the cursor moves to the last character of the field (Recall function). The Recalled Adjective or Noun field may now be changed letter-by-letter
- If the zero key is pressed again with no other intervening key actions and the last character in the field is a number 0-9, the number is incremented by one. If the last character is a letter, it changes to a 0. If the last character goes from 9 to 0 and the characters to the left of the last character are also numbers, they are also incremented (overflow)
- The above increment function may be repeated with each press of the zero key

As an example, the user could quickly enter 'FLR_3_ROOM 305' as follows:

1. The cursor is on the first letter of the Adjective field. Press the zero key twice to display *FLR_3*
2. With the cursor on the first letter of the Noun field, press the zero key twice to recall the display *ROOM_304*. The cursor automatically jumps from the first to the last letter of the Noun field
3. With the cursor on the last letter of the Noun field, press the zero key again to increment the room number to *305*
4. Press the right arrow key to advance the zone field
5. Select a zone number from 00 to 99. Z00 (default zone) is the general alarm zone. Z01 through Z99 may be selected to link software zones

```

PROGRAMMING
1=AUTO PROGRAM
2=POINT PROGRAM
3=ZONE SETUP
Programming Screen #2

```

3.6.3 Zone Setup

Pressing 3 while viewing Programming Screen #2 will access the Zone Setup screens as illustrated below:

```

ZONE SETUP
1=ENABLE
2=DISABLE
3=ZONE 97 98 99

```

Zone Setup Screen #1

```

ZONE SETUP
1=ZONES INSTALLED
2=ZONES ENABLED
3=ZONES DISABLED

```

Zone Setup Screen #2

```

ZONE SETUP
1=ZONE TYPES
2=ZONES AVAILABLE

```

Zone Setup Screen #3

```

ZONE SETUP
1=ENABLE
2=DISABLE
3=ZONE 97 98 99

```

Zone Setup Screen #1

3.6.3.1 Enable

Pressing 1 for Enable, while viewing Zone Setup Screen #1, will display the following screen:

```

ZONE TO ENABLE
Z █

```

Enable Screen

This screens allows the programmer to enable zones, one at a time. A flashing cursor appears next to the Z, prompting the programmer to enter a two digit zone number (01 - 99). When the second digit is entered, the zone will be enabled and the cursor returns to the original position next to the Z. Another zone can then be enabled.

```

ZONE SETUP
1=ENABLE
2=DISABLE
3=ZONE 97 98 99
Zone Setup Screen #1

```

3.6.3.2 Disable

Pressing 2 for Disable, while viewing Zone Setup Screen #1, displays the following:

```

ZONE TO DISABLE
Z

```

Disable Screen

This screen allows the programmer to disable zones, one at a time. A flashing cursor appears next to the Z, prompting the programmer to enter a two digit zone number (01 - 99). When the second digit is entered, the zone will be disabled and the cursor will return to the original position next to the Z. Another zone can then be disabled.

3.6.3.3 Zone 97, 98 and 99

Pressing 3 for Zone 97, 98 and 99, while viewing Zone Setup Screen #1, will display the following screen:

```

SPEC PURPOSE ZONE
1=PAS 97 OFF
2=PRE SIGNAL 98 OFF
3=ZONE 99 OFF

```

Zone 97, 98 and 99 Screen

Zones 97, 98 and 99 can be programmed for normal zone operation or for special purpose applications. In the above illustration, the three zones are shown Off, which means they can be programmed to function in the same manner as all other zones, by assigning them to input and output devices in the Programming Zone Assignment Screen.

Pressing 1 will cause the display to change to *PAS 97 On*. Each press of the 1 key will cause the display to toggle between *PAS 97 On* and *PAS 97 Off*. When Zone 97 is programmed On, a PAS (Positive Alarm Sequence) activation of any device will cause Zone 97 to activate. By assigning Zone 97 to a control module in the Programming Zone Assignment Screen, an output device connected to the control module can be used to indicate a PAS condition in the control panel. *Do not assign Zone 97 to a Notification Appliance Circuit when using this zone to indicate a PAS condition. Attempting to do so will generate an error message and will be prevented by software checks.*

Pressing 2 will cause the display to change to *Pre-signal 98 On*. Each press of the 2 key will cause the display to toggle between *Pre-signal 98 On* and *Pre-signal 98 Off*. When Zone 98 is programmed On, a Pre-signal activation of any device will cause Zone 98 to activate. By assigning Zone 98 to a control module in the Programming Zone Assignment Screen, an output device connected to the control module can be used to indicate a Pre-signal condition in the control panel. *Do not assign Zone 98 to a Notification Appliance Circuit when using this zone to indicate a Pre-signal condition. Attempting to do so will generate an error message and will be prevented by software checks.*

Zone 99, in special purpose mode, is reserved for future use and has no effect.

```

ZONE SETUP
1=ZONES INSTALLED
2=ZONES ENABLED
3=ZONES DISABLED
Zone Setup Screen #2

```

3.6.3.4 Zones Installed

Pressing 1 for Zones Installed, while viewing Zone Setup Screen #2, will display a screen similar to the following:

```

ZONES INSTALLED
00 01 02 03 04 05

```

Zones Installed Screen

This display will show all of the zones that have been programmed into the control panel. Note that an up and/or down arrow may appear in the upper right corner of the display, indicating that additional screens of zone information exists. Press the up or down arrow keys to view the additional zones.

3.6.3.5 Zones Enabled

Pressing 2 for Zones Enabled, while viewing Zone Setup Screen #2, will display a screen similar to the following:

```

ZONES ENABLED
00 01 02 04 05 06 07
08 09 10 11 12 13 14
15 16 17 18 19 20 21

```

Zones Enabled Screen

This display will show all of the zones that are enabled in the control panel. Note that an up and/or down arrow may appear in the upper right corner of the display, indicating that additional screens of zone information exists. Press the up or down arrow keys to view the additional zones.

3.6.3.6 Zones Disabled

Pressing 3 for Zones Disabled, while viewing Zone Setup Screen #2, will display a screen similar to the following:

```

ZONES DISABLED
03

```

Zones Disabled Screen

This display will show all of the zones that are disabled in the control panel. Note that an up and/or down arrow may appear in the upper right corner of the display, indicating that additional screens of zone information exists. Press the up or down arrow keys to view the additional zones.

```

ZONE SETUP
1=ZONE TYPES
2=ZONES AVAILABLE
    
```

Zone Setup Screen #3

3.6.3.7 Zone Type

Zone Types must be programmed only if a DACT, programmed for zone reporting, is installed on the control panel. Pressing 1 for Zone Types, while viewing Zone Setup Screen #3, will display a screen similar to the following:

```

ZONE TYPE PROG
1=Z00 MONITOR
2=Z01 MONITOR
3=Z02 MONITOR
    
```

Zones Installed Screen

This display will show the system zones (default and user programmed) and their associated types. Note that an up and/or down arrow will appear in the upper right corner of the display, indicating that additional screens of zone information exists. Press the up or down arrow keys to view zones Z00 through Z99.

Zone types can be changed by pressing the keypad number key corresponding to the zone in each Zones Installed Screen. Available zone types will be displayed in the resultant screens. For example, to change the zone type for zone Z02 in the screen illustrated above, press 3. The following screens will be displayed:

```

ZONE TYPE PROG
1=MONITOR
2=SMOKE PHOTO
3=WATERFLOW
    
```

Zone Type Program Screen #1

```

ZONE TYPE PROG
1=MEDICAL
2=HAZARD
3=TAMPER
    
```

Zone Type Program Screen #3

```

ZONE TYPE PROG
1=HEAT
2=PULL STATION
3=DUCT
    
```

Zone Type Program Screen #2

```

ZONE TYPE PROG
1=SUPERVISORY
2=PROC. MON
3=SMOKE ION
    
```

Zone Type Program Screen #4

To change the zone type for Z02 to Pull Station, scroll the display until Zone Type Program Screen #2 is displayed. Press 2 to program zone Z02 as a Pull Station zone. The display will return to the Zones Installed Screen showing zone Z02 and the Pull Station program type. Repeat the procedure for each zone to be changed.

IMPORTANT! In Zone Type Program Screen #1, selecting WATERFLOW will assign a Waterflow silenceable zone type to the selected zone. Any signaling devices programmed to the same zone can be silenced by pressing the Alarm Silence key or by using the auto-silence feature.

To program a waterflow circuit as nonsilenceable, refer to "System Setup" on page 82.

Note: Zone Types are only relevant for Central Station reporting. Changing a zone type will only change how it is reported to the Central Station.

ZONE SETUP
1=ZONE TYPES
2=ZONES AVAILABLE

Zone Setup Screen #3

3.6.3.8 Zones Available

Pressing 2 while viewing Zone Setup Screen #3 will display a screen similar to the following:

```

ZONES AVAILABLE
01 02 03 04 05 06 07
08 09 10 11 12 13 14
15 16 17 18 19 20 21
    
```

The display will show all of the zones that are still available for programming. Note that an up and/or down arrow may appear in the upper right corner of the display, indicating that additional screens of zone information exists. Press the up or down arrow key to view additional screens.

PROGRAMMING
1=LOOP SETUP
2=SYSTEM SETUP
3=VERIFY LOOP

Programming Screen #2

3.6.4 Loop Setup

Loop Setup allows the programmer to configure the SLC Loop for NFPA Style 4, 6 or 7 wiring and to select the loop protocol. Pressing 1 while viewing Programming Screen #2 will cause the following screen to be displayed:

```

      LOOP SETUP
1=STYLE           4
2=PROTOCOL       CLIP
    
```

Loop Setup Screen

3.6.4.1 Style

To program the SLC Style for the selected loop, press 1 for Style, while viewing Loop Setup Screen. In the preceding example, the control panel is programmed for Style 4 SLC wiring as indicated by the 4 to the right of *Style* in the display. To change the wiring style, press 1 to toggle the display to read *Style 6*. Each press of the 1 key will cause the display to toggle between *Style 4* and *Style 6*. *Note that, when programming the Loop Style, the programmer can only select between Style 4 and Style 6. To program a system for Style 7 wiring, the programmer must select the Loop Setup for Style 6. Style 7 wiring is the same as Style 6 with the added requirement that each addressable device on the loop must have a pair of isolator modules, one on each side.*

3.6.4.2 Loop Protocol

Loop Protocol refers to the SLC loop mode of operation. At the present time, the only mode available is CLIP (Classic Loop Interface Protocol) which is used for the older legacy addressable devices such as the M300 Series modules and detectors. Note that the legacy devices can operate only in CLIP mode while the newer devices are compatible with CLIP and any future modes of operation. Pressing 2 while viewing the Loop Setup Screen will have no effect on programming at this time.

Device Addressing

It is important to note that the MS-9200UD addressable device capacity is 99 detectors and 99 control/monitor modules. Newer devices can be set to addresses higher than 99 but these addresses will not function with the MS-9200UD.

Note that It is permissible to mix old and new devices on the same loop.

3.6.5 System Setup

System Setup allows the programmer to configure the following control panel features:

- *Trouble Reminder*: This feature, when enabled, provides an audible reminder that an alarm or trouble still exists on the FACP after the control panel has been silenced. The control panel piezo sounder will pulse once every 15 seconds during an alarm and every two minutes during a trouble condition, after the Alarm Silence or Acknowledge key is pressed. The piezo will continue to sound at these rates until the alarm or trouble condition is cleared. If the trouble condition is not cleared within 24 hours, the panel will reactivate the trouble sounder and retransmit the trouble condition to the central station if connected.
- *Banner*: This option allows the user to change the top two lines of the LCD display from the factory default readout of *FIRE-LITE ALARMS INC* to a user defined readout when the control panel is in Normal condition.
- *Time-Date*: This feature allows the programmer to set the time, display format (24 hr or 12 hr), date and daylight savings time feature into the FACP memory
- *Timers*: This option allows the programmer to set the PAS (Positive Alarm Sequence) time delay, Pre-Signal time delay and Waterflow time delay.
- *NACs*: This feature allows the programmer to configure the control panel Notification Appliance Circuits for a variety of options, such as circuit type, silenceable/nonsilenceable, autosilence, coding, silence inhibit, zone assignment and enable/disable.
- *Relays*: This option allows programming of two onboard relays for activation by various control panel events, such as alarm, trouble, supervisory, etc.
- *Canadian Option*: This option allows the automatic programming of ionization smoke detector sensitivity thresholds to Canadian specifications.
- *Waterflow Silenceable*: This option provides the ability to silence any output circuit activated by a monitor module programmed as a waterflow type.

PROGRAMMING
1=LOOP SETUP
2=SYSTEM SETUP
3=VERIFY LOOP

Programming Screen #2

Pressing 2 for System Setup, while viewing Programming Screen #2, will cause the following screens to be displayed:

SYSTEM SETUP 
1=TROUBLE REM OFF
2=BANNER
3=TIME-DATE

System Setup Screen #1

SYSTEM SETUP 
1=TIMERS
2=NAC
3=RELAYS

System Setup Screen #2

SYSTEM SETUP 
1=CANADIAN OPT. OFF
2=WATERFLOW SIL. NO

System Setup Screen #3

3.6.5.1 Trouble Reminder

The Trouble Reminder features causes the control panel piezo to sound a reminder 'beep' for alarms and troubles, after the panel has been silenced. Refer to "System Setup" on page 82, for a detailed description of this feature. Pressing 1 while viewing System Setup Screen #1 will cause the display to toggle to *Trouble Rem On*, which enables this feature. Each press of the 1 key will cause the display to toggle between *Trouble Rem On* and *Trouble Rem Off*.



3.6.5.2 Banner

The top line of the display, which appears when the control panel is in normal mode, can be changed by using the Banner option. Pressing 2 while viewing System Setup Screen #1 will cause the following to be displayed:



Banner Screen



Banner Screen

Pressing 1 while viewing the Banner Screen will select the factory default banner setting and display the following screen:

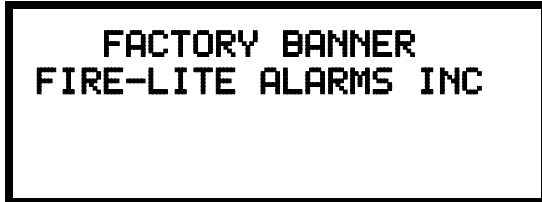

Factory Banner Screen

Pressing the Enter key will store this selection in nonvolatile memory and return the display to the Banner Screen.

Pressing 2 while viewing the Banner Screen will cause the following screens to be displayed:

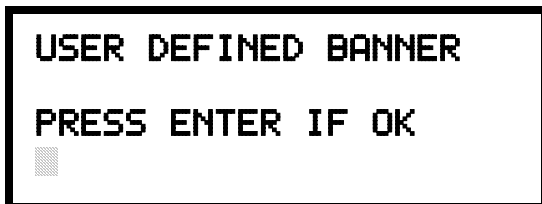

User Defined Banner Screen #1



User Defined Banner Screen #2

These screens allow the programmer to enter a two line custom banner. A flashing cursor will appear in the bottom left corner of each display. A maximum of 20 characters (including spaces) can be entered into each screen for a total of two lines with 40 characters. After entering up to 20 characters in the first screen, press *Enter* to view the second screen. Enter up to 20 characters in the second screen in the same manner or just press *Enter* if a second banner line is not being entered. To quickly clear the current banner, press the *CLR* key.

To enter alphanumeric characters from the keypad, repeatedly press the appropriate key until the desired character is displayed in the first position. For example, to enter the letter *B*, press the *2 (ABC)* key three times to toggle through the characters *I*, *A* and *B*. Press the right arrow key to move the cursor one position to the right and repeat the process to enter the next character. To enter a space, press the **(QZ)* key four times to place a blank in the desired position. When all characters have been entered, press the *Enter* key to store the information. The display will return to the Banner Screen.

```

SYSTEM SETUP
1=TROUBLE REM
2=BANNER
3=TIME-DATE
    
```

System Setup Screen #1

3.6.5.3 Time-Date

The control panel time and date can be changed by pressing 3 while viewing the System Setup Screen #1. The following screen will be displayed:

```

TIME AND DATE
1=TIME 10:00 AM
2=DATE 04-07-2002
3=CLOCK FORMAT 12HR
    
```

Time-Date Screen #1

```

TIME AND DATE
1=DAYLIGHT SAVINGS
    
```

Time-Date Screen #2

3.6.5.3.1 Time

To change the time, press *1* while viewing the Time-Date Screen. The following screen will be displayed:

```

ENTER TIME
10:00 AM
1=AM 2=PM
    
```

Time Screen

A flashing cursor is located toward the top left of the display. Below the cursor is the current time. To change the time, enter the two-digit hours followed by the two-digit minutes. The cursor will move one position to the right each time a digit is entered. After the last minutes digit is entered, the cursor will again move one position to the right. At this point enter *1* for AM or *2* for PM. The display will then return to the Time-Date Screen which will show the new time entry. If an error is made while entering a digit, press the *CLR* key to delete the entire entry and beginning again.

3.6.5.3.2 Date

To change the date, press 2 while viewing the Time-Date Screen. The following screen will be displayed:



Date Screen

A flashing cursor is located toward the top left of the display. Below the cursor is the current date. To change the date, enter the two-digit month followed by the two-digit day and then the two-digit year (01 for 2001, 02 for 2002, etc.). The cursor will move one position to the right each time a digit is entered. After the last year digit is entered, the display will return to the Time-Date Screen which will show the new date entry. If an error is made while entering a digit, press the CLR key to delete the entire entry and beginning again.

3.6.5.3.3 Clock Format

The clock can be configured to display 12 hour (AM & PM) or 24 hour (military) time. Pressing 3 while viewing the Time-Date screen will cause the display to toggle between 12HR and 24HR. Select 12HR for 12 hour display or 24HR for 24 hour display.

Note: If the clock is changed to 24 hour (military) format, the date will change to the European standard of Day-Month-Year (for display purposes only).



Time & Date Screen #2

3.6.5.3.4 Daylight Savings Time

Pressing 1 while viewing Time-Date Screen #2 will cause the following screens to be displayed:



Daylight Savings Screen #1



Daylight Savings Screen #2

Pressing 1 while viewing Daylight Savings Screen #1 will cause the display to toggle between *Enabled Yes* and *Enabled No*. The control panel will automatically update the time for daylight savings time when *Enabled Yes* is selected.

Pressing 2 while viewing Daylight Savings Screen #1 will display another screen which allows the programmer to select the month that daylight savings time will begin. In this sub-screen, pressing 1 will select March, 2 will select April and 3 will select May.

Pressing 3 while viewing Daylight Savings Screen #1 will display two sub-screens which allow the programmer to select the week of the month that daylight savings time will begin. In the first sub-screen, pressing 1 will select the first week, 2 will select the second week and 3 will select the third week, while in the second sub-screen, pressing 1 will select the fourth week and 2 will select the last week of the selected month.

Pressing 1 while viewing Daylight Savings Screen #2 will display another screen which allows the programmer to select the month that daylight savings time will end. In this sub-screen, pressing 1 will select September, 2 will select October and 3 will select November.

Pressing 2 while viewing Daylight Savings Screen #2 will display two sub-screens which allow the programmer to select the week of the month that daylight savings time will end. In the first sub-screen, pressing 1 will select the first week, 2 will select the second week and 3 will select the third week, while in the second sub-screen, pressing 4 will select the fourth week and 5 will select the last week of the selected month.

```

SYSTEM SETUP
1=TIMERS
2=NAC
3=RELAYS
    
```

System Setup Screen #2

3.6.5.4 Timers

Timer delays for PAS, Pre-signal and waterflow activation can be programmed by pressing 1 while viewing System Setup Screen #2. The following screen will be displayed:

```

          TIMERS
1=PAS DELAY    000
2=PRE SIGNAL   000
3=WATERFLOW    000
    
```

Timer Screen #1

```

          TIMERS
1=AC LOSS DELAY 000
    
```

Timer Screen #2

```

TIMERS
1=PAS DELAY    000
2=PRE SIGNAL   000
3=WATERFLOW    000
    
```

Timer Screen #1

3.6.5.4.1 PAS (Positive Alarm Sequence) Delay

The factory default setting for PAS is 000 for no delay. To select a PAS delay of 001 to 180 seconds for all devices programmed for PAS, press 1 while viewing Timer Screen #1. The following display will appear:

```

          PAS DELAY
RANGE 0-180 SECONDS
    
```

PAS Delay Screen

A flashing cursor is positioned in the lower left corner of the display. Enter a delay time consisting of three digits, such as 005 for five seconds. Upon entering the third digit, the time delay will be stored in the control panel memory and the display will return to the Delay Screen which will indicate the new delay time.

3.6.5.4.2 Pre-signal Delay

The factory default setting for Pre-signal delay is 000 for no delay. To select a Pre-signal delay of 001 to 180 seconds for all devices programmed for Pre-signal, press 2 while viewing Timer Screen #1. The following screen will be displayed:



Pre-signal Delay Screen

A flashing cursor is positioned in the lower left corner of the display. Enter a delay time consisting of three digits, such as 009 for nine seconds. Upon entering the third digit, the time delay will be stored in the control panel memory and the display will return to the Delay Screen which will indicate the new delay time.

Note that the FACP can be programmed for either PAS or Pre-signal operation, not both. For this reason, if the PAS Delay timer is set with a value greater than 000 and then the Pre-Signal Delay timer is set with a value greater than 000, the PAS Delay timer will be automatically reset to 000. Only one of the two timers can have a delay time set for it.

TIMER	
1=	PAS DELAY 000
2=	PRE SIGNAL 000
3=	WATERFLOW 000

Timer Screen #1

3.6.5.4.3 Waterflow Delay

A delay can be added prior to declaring a waterflow type of alarm. Be careful to include any built-in delays of the waterflow device. The factory default setting for Waterflow delay is 000 for no delay. To select a Waterflow delay of 01 to 90 seconds for all devices programmed for Waterflow delay, press 3 while viewing Timer Screen #1. The following screen will be displayed:



Waterflow Delay Screen

A flashing cursor is positioned in the lower left corner of the display. Enter a delay time consisting of two digits, such as 25 for twenty-five seconds. Upon entering the second digit, the time delay will be stored in the control panel memory and the display will return to the Delay Screen which will indicate the new delay time.



Timer Screen #2

3.6.5.4.4 AC Loss Delay

The reporting of a loss of AC power to a central station can be delayed by programming the length of the desired delay. Press 1 while viewing Timer Screen #2 to display the following:

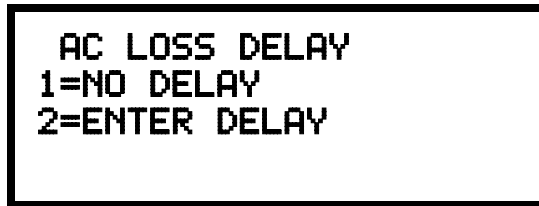

AC Loss Delay Screen #1

Pressing 1 while viewing AC Loss Delay Screen #1 will program the FACP to transmit an AC Loss report immediately to the central station.

Pressing 2 while viewing AC Loss Delay Screen #1 will display the following:



AC Loss Delay Screen #2

A flashing cursor will appear in the lower left corner of the display. Type the two digit AC loss reporting delay in hours (00 to 23 hour delay). When the second digit is entered, the display will return to AC Loss Delay Screen #1.

Important: For Central Station applications, AC Loss Reporting Delay must be set to a delay value ranging from 06 to 12 hours. For Remote Station applications, AC Loss Reporting Delay must be set to a delay value ranging from 15 to 23 hours.

Note: AC Loss Delay also applies to any programmable output relay programmed for 'AC Loss.'

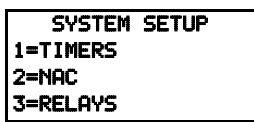

System Setup Screen #2

3.6.5.5 NAC (Notification Appliance Circuit)

The options for the NACs on the control panel main circuit board can be configure by pressing 2 while viewing System Setup Screen #2. The following screens will be displayed:

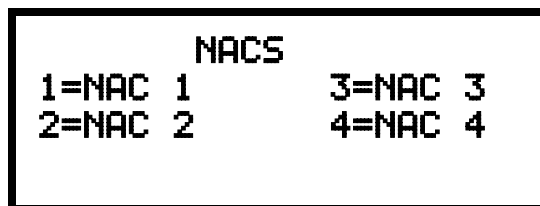

NAC Selection Screen

The Notification Appliance Circuits can be configured independently by pressing 1 for NAC 1, 2 for NAC 2, 3 for NAC 3 or 4 for NAC 4.

Note that 3=NAC 3 and 4=NAC 4 will be displayed, and can be programmed, regardless of how the NACKEY card is installed. Their programming, however, will have no effect if the NACKEY card is installed for Class A operation.

The following screens will be displayed for each selection:



NAC Screen #1



NAC Screen #2

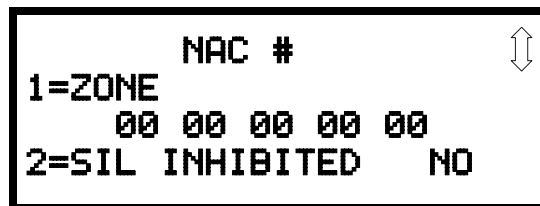

NAC Screen #3



NAC Screen #4

3.6.5.5.1 Enabled

Pressing *I* while viewing NAC Screen #1 will cause the display to change to *Enabled No*. This will prevent the selected main circuit board NAC from activating its devices. Each press of the *I* key will cause the display to toggle between *Enabled Yes* and *Enabled No*.

Note: The programming for NAC 1 will determine the operation of the remote power supply sync.

<p>NAC # 1=ENABLED 2=TYPE 3=SILENCEABLE</p>
--

NAC Screen #1

3.6.5.5.2 Type

The main circuit board NAC type can be programmed by pressing 2 while viewing NAC Screen #1. The following screens will be displayed:

<p>NAC TYPE</p> <p>1=BELL 2=HORN 3=STROBE</p>

Type Screen #1

<p>NAC TYPE</p> <p>1=SYNCED STROBE 2=FUTURE 3=AUDIBLE</p>

Type Screen #2

<p>NAC TYPE</p> <p>1=FUTURE 2=SIREN CIRCUIT 3=BLANK</p>

Type Screen #3

Select the NAC device type by pressing the number corresponding to the type in the appropriate screen as shown above. When the selection is made, the display will return to NAC Screen #1.

The following table contains NAC type codes and their functions:

NAC Type Code	Special Function
Bell	None
Horn	None
Strobe	None
Synced Strobe	Synchronized to manufacturer
Audible	None
Siren Circuit	None
Blank	None

3.6.5.5.3 Silenceable

Pressing 3 while viewing NAC Screen #1 will cause the display to change to *Silenceable No*. This will prevent the selected main circuit board NAC from being silenced by pressing the Alarm Silence key or by the Auto Silence feature. Each press of the 3 key will cause the display to toggle between *Silenceable Yes* and *Silenceable No*.

Important: When a Notification Appliance Circuit with a mix of audible and visual devices is programmed for silenceable and the synchronization feature is selected, only the audible devices will be turned off if the Silence key is pressed or if the Autosilence feature is enabled. The visual devices (strobes, etc.) will continue to operate.

NAC #
1=AUTO SILENCE
2=CODING
TEMPORAL

NAC Screen #2

3.6.5.5.4 Auto Silence

The Auto Silence feature, when enabled, automatically silences all main circuit board silenceable notification appliances after a programmed length of time. To enable this feature and program the time delay before Auto Silence activation, press 1 while viewing NAC Screen #2. The following screens will be displayed:

AUTO SILENCE	↓
1=NO	
2=5 MINUTES	
3=10 MINUTES	

Auto Silence Screen #1

AUTO SILENCE	↕
1=15 MINUTES	
2=20 MINUTES	
3=25 MINUTES	

Auto Silence Screen #2

AUTO SILENCE	↑
1=30 MINUTES	

Auto Silence Screen #3

To disable the Auto Silence feature, press 1 for No while viewing Auto Silence Screen #1. To enable the Auto Silence feature, press the number corresponding to the time delay which will elapse before Auto Silence activates. This information will be stored in memory and the display will return to NAC Screen #2.

Note: All silenceable control modules as well as the remote power supply sync will be controlled by the Autosilence timer for NAC 1.

3.6.5.5.5 Coding (only for NACs not programmed as Sync Strobe Type)

The Coding feature allows the programmer to select the type of output that the main circuit board notification appliances will generate when activated. Pressing 2 while viewing NAC Screen #2 will cause the following displays to appear:

CODING	↓
1=STEADY	
2=MARCH TIME	
3=CALIFORNIA	

Coding Screen #1

CODING	↑
1=TEMPORAL	
2=TWO STAGE	

Coding Screen #2

The programmer can select the notification appliance output by pressing the number corresponding to the desired output. The coding selections are:

- Steady - a continuous output with no coding
- March Time - 120 ppm (pulse-per-minute) output
- California - 10 seconds on and 5 seconds off
- Temporal - ½ second on, ½ second off, ½ second on, ½ second off, ½ second on, 1½ second off
- Two Stage - refer to "Two Stage Operation" on page 92 for a description

Selection of one of the above options will cause the control panel to store the information in memory and return the display to NAC Screen #2, which will display the new coding choice.

3.6.5.5.1 Two Stage Operation

Two Stage operation consists of the following:

- 1st stage output - 20 ppm (pulse-per-minute) coding
- 2nd stage output - Temporal coding as described above

If Two Stage operation is programmed as the Coding option, the following sequence of events will occur during an alarm.

1. The on-board NACs which are programmed to General Alarm Zone 0 will activate with a 1st stage output upon activation of any alarm point
2. If the activated alarm point is directly mapped to a zone which is programmed to an on-board NAC, that NAC will go directly to 2nd stage coding output. All other NACs not directly mapped to the activated alarm point's zone but assigned to Zone 0 will activate with a 1st stage output
3. If, after the programmed time of 3 or 5 minutes, the Acknowledge switch has not been pressed, all NACs presently in 1st stage activation will go to 2nd stage activation
4. If an Acknowledge switch has been pressed, any NACs currently in 1st stage activation will remain in 1st stage. Pressing the Acknowledge switch does not affect NACs already in 2nd stage activation
5. If another alarm point is activated and the countdown timer is counting, the alarm point will have no effect on the NACs unless the alarm point's zones are directly mapped to one of the NACs, in which case it will follow the procedure outlined in step 2
6. If another alarm point is activated and the countdown timer has stopped counting due to the Acknowledge switch being pressed, the countdown timer will restart and the NACs will respond as outlined in step 2. NACs already in 2nd stage activation will not be affected
7. Any control modules assigned to special Zone 99 will be activated either by direct mapping of an input device programmed to Zone 99 or if the timer counts down to zero
8. Control modules that are programmed to the same zone as the activated input device will not be delayed for activation

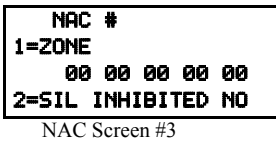

3.6.5.5.6 Zone

A maximum of five zones can be programmed to each main circuit board NAC. Pressing 1 while viewing NAC Screen #3 displays the following screen:

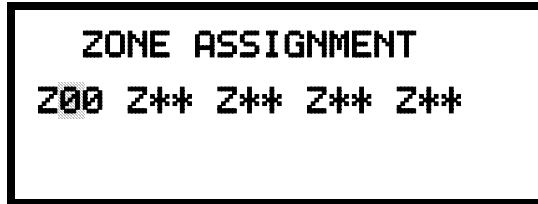

Zone Screen

Note that Z** represents the Zone Number(s) corresponding to the selected NAC. The factory default for an unprogrammed device is Z00 for general alarm zone. A flashing cursor will appear on the first 0 to the left. Enter the two digit number corresponding to the zone that is to be assigned to this NAC. The cursor moves to the next Z** designation. Continue entering zone assignments or the remaining zones can be left blank or programmed as general alarm zone Z00. When all desired changes have been made, press the Enter key to store the zone assignments. The display will return to the NAC Screen #3 which will show the zone assignments just entered.

3.6.5.5.7 Silence Inhibited

The Silence Inhibit feature, when enabled, prevents the silencing of the selected main circuit board NAC for a period of one minute. Resetting the FACP will also be prevented for one minute while the NAC programmed for silence inhibit is activated. Pressing 2 while viewing NAC Screen #3 will cause the display to change from the factory default of *Silence Inhibit No* to *Silence Inhibit Yes*. Each press of the 2 key will cause the display to toggle between the two options.

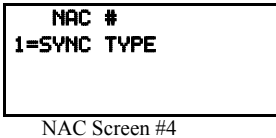

3.6.5.5.8 Sync Type

If synchronized strobes were selected as the Type of device installed, the type of synchronization must be selected in this option. Pressing 1 while viewing NAC Screen #4 will cause the following screen to be displayed:

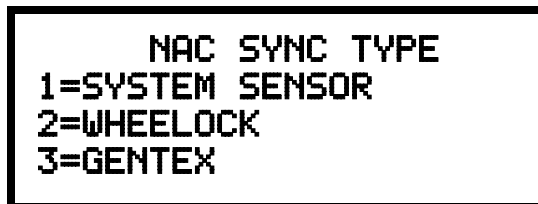

Pressing 1 while viewing this screen will select System Sensor synchronization, 2 will select Wheelock and 3 will select Gentex.

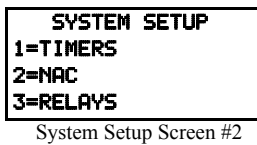

3.6.5.6 Relays

Pressing 3 while viewing System Setup Screen #2 will allow the programmer to configure two of the three main circuit board Form-C relays. The following screen will be displayed:

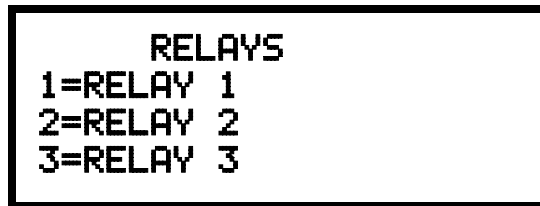

Relays Selection Screen

To program Relay 1 or Relay 3, press the number corresponding to the selected relay. Note that Relay 2 is fixed as a Trouble relay. Selecting Relay 2 will have no effect on its programming. The following screen will appear for each relay to be programmed:



Relay Type Screen

Pressing 1 for Type while viewing the Relay Screen will cause the following screens to be displayed:

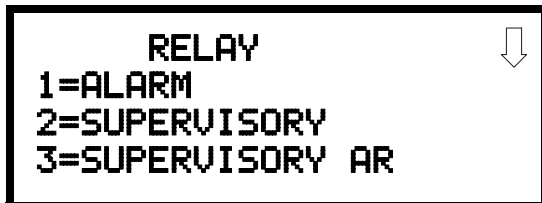

Relay Screen #1



Relay Screen #3

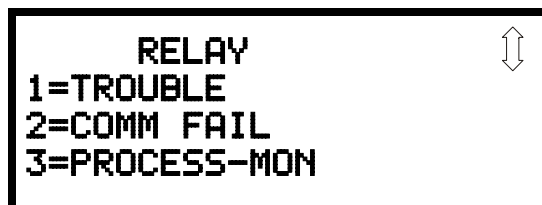

Relay Screen #2



Relay Screen #4

While viewing the selected screen, press the number corresponding to the desired relay type to program the main circuit board relay. The choice will be stored in memory and the display will return to the Relay Type Screen which will show the programmed type choice. Press the Escape key to return to the Relays Selection Screen and repeat the preceding procedure for the remaining relays.

Note: *AR* in *SUPERVISORY AR* and *PROCMON AR* indicates AutoResettable which means that the relay will not latch when either of these conditions occur. If the corresponding condition is cleared, the relay will return to its normal state without the necessity of resetting the control panel.

```

SYSTEM SETUP
1=CANADIAN OPT. OFF
2=WATERFLOW SIL. NO
    
```

System Setup Screen #3

3.6.5.7 Canadian Option

Pressing 1 while viewing System Setup Screen #3 will allow the programmer to configure the system to automatically monitor addressable ionization smoke detector sensitivity using Canadian specifications. The display will change to *Canadian Opt. On*. Each press of the 1 key will cause the display to toggle between *Canadian Opt. On* and *Canadian Opt. Off*:

```

SYSTEM SETUP
1=CANADIAN OPT. OFF
2=WATERFLOW SIL. NO
    
```

Relays Selection Screen

3.6.5.8 Waterflow Silenceable

Pressing 2 while viewing System Setup Screen #3 will allow the programmer to configure the system for silenceable on nonsilenceable waterflow circuits. Each press of the 2 key will toggle the display between *Waterflow Sil. No* and *Waterflow Sil. Yes*. When *Waterflow Sil. No* is selected, all output devices associated with a waterflow type input device, will be nonsilenceable. When *Waterflow Sil. Yes* is selected, all output devices associated with a waterflow type input device, will be silenceable.

3.6.6 Verify Loop

```

PROGRAMMING
1=LOOP SETUP
2=SYSTEM SETUP
3=VERIFY LOOP
    
```

Programming Screen #2

Pressing 3 while viewing Programming Screen #2, will select the Verify Loop option. During loop verification, the FACP polls each device on the SLC to determine if the device is communicating and whether or not it responds with the proper type identification. The following screen will be displayed while verification is in progress:

```

VERIFYING LOOPS
PLEASE WAIT
    
```

Verification Progress Screen

When Loop verification has been completed, the display will indicate that the system is OK or, if problems have been detected, any device type programming errors. Use the up and down arrow keys to view all detected errors.

3.6.7 History

```

PROGRAMMING
1=HISTORY
2=WALKTEST
3=OPTION MODULES

```

Programming Screen #3

The History option allows an authorized user to view or erase events which have occurred in the control panel. Pressing *1* while viewing Programming Screen #3 will display the History options as shown in the following display:

```

HISTORY
1=VIEW EVENTS
2=ERASE HISTORY

```

History Screen

```

HISTORY
1=VIEW EVENTS
2=ERASE HISTORY

```

History Screen

3.6.7.1 View Events

Pressing *1* while viewing the History Screen will allow the user to select the events to be viewed as illustrated in the following:

```

HISTORY
1=VIEW ALL
2=VIEW ALARMS
3=VIEW OTHER EVENTS

```

View Events Screen

While displaying the View Events screen, press *1* to view all events, *2* to view only alarms or *3* to view other events. Use the up and down arrow keys to scroll through all of the displayed events.

3.6.7.2 Erase History

The Erase History option allows a user to erase all events from the history file. This will provide a clean slate in order to use the history file to track future events. Pressing *2* while viewing the History Screen will display the following screen:

```

ERASE HISTORY
PROCEED ?
1=YES          2=NO

```

Erase History Screen

Pressing *1* while viewing the Erase History Screen will erase all events from the History file. During this process, the display will read as follows:

```

ERASING HISTORY
PLEASE WAIT

```

Erase History Wait Screen

After the History file has been erased, the display will return to the History Screen.

3.6.8 Walktest

PROGRAMMING
1=HISTORY
2=WALKTEST
3=OPTION MODULES

Programming Screen #3

Walktest allows an individual to test the fire alarm system without the necessity to reset the control panel after each device activation. Pressing 2 while viewing the Programming Screen #3 will cause the following Walktest options to be displayed:

```

WALKTEST
1=SILENT
2=AUDIBLE
3=VIEW RESULT
    
```

Walktest Screen

To perform a silent walktest which will not sound the NACs, press 1 while viewing the Walktest Screen. To perform an audible walktest, which will sound the NACs, press 2 while viewing the Walktest Screen. When either option is chosen, the panel will enter Walktest Mode and the following screen will be displayed:

```

UNIT IN WALKTEST
    
```

Walktest Active Screen

The user can now perform a one-person walktest by activating devices throughout the system. As each device is activated, the screen will display the information about the activated device as shown below. Note that the colon (:) in the time is replaced with an asterisk (*) to distinguish the walktest screen from an actual alarm screen.

```

ALARM PULL STATION
<ADJ> <NOUN>
                Z000
10*00A 010801 1M001
    
```

After completion of the Walktest, press the *Esc* (Escape) key to exit Walktest Mode and return to the Walktest Screen. The results of the Walktest can now be viewed by pressing 3 while viewing the Walktest Screen. The following screen will be displayed:

```

WALKTEST RESULTS
    
```

View Result Screen

Use the up and down arrow keys to view all of the walktest results which will be displayed as illustrated in the preceding screen. Note that the Walktest log is stored in RAM. If all power (AC and DC) is removed from the FACP, the Walktest log information will be lost. This information is also overwritten when subsequent walktests are performed.

3.6.9 Option Modules

```

PROGRAMMING
1=HISTORY
2=WALKTEST
3=OPTION MODULES

```

Programming Screen #3

Options available for the MS-9200UD include ACM Series, Graphic and LCD annunciators, printer connection for acquiring hardcopy printouts of panel data and PC (Personal Computer) connection for uploading and downloading panel data.

Pressing 3 while viewing Programming Screen #3 will display the following screen:

```

OPTION MODULES
1=ANNUNCIATORS/UDACT
2=ONBOARD DACT
3=PRINTER/PC PR4800

```

Options Screen

Note that *PR4800* in the display indicates that a supervised printer, configured for 4800 baud, has been previously programmed into the system.

3.6.9.1 Annunciators/UDACT

Pressing 1 while viewing the Options Screen will cause the control panel to display the following screens:

```

ANNUNCIATOR
1=TERM ENABLED YES
2=ACS ENABLED YES
3=UDACT YES

```

Annunciator Screen #1

```

ANNUNCIATOR
1=ACS INSTALLED

```

Annunciator Screen #2

A Terminal Mode annunciator* and ACS Mode annunciator can be installed in the MS-9200UD system. To enable any of these devices, press the number corresponding to the selected device shown in Annunciator Screen #1 so that *Yes* appears in the display to the right of the device. Each press of the corresponding number key will cause the display to toggle between *Enabled Yes* and *Enabled No*.

Notes:

1. *The LCD-80F is a Terminal Mode annunciator. To enable the MS-9200UD for LCD-80F operation, program *Term Enabled* to *Yes*.
2. The Terminal Mode annunciator (LCD-80F) and the Printer/PC use the same TB8 terminal block on the MS-9200UD main circuit board. Only one device can be connected at one time, therefore, programming *Term Enabled* to *Yes* will disable any Printer/PC communications.

If an ACS annunciator is installed, press *1* while viewing Annunciator Screen #2 to select addresses for the ACS annunciators. The following screen will be displayed:

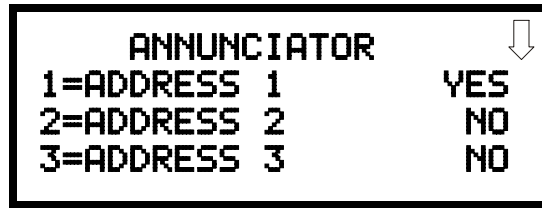

ACS Installed Screen

Pressing the down arrow key will allow the programmer to view additional screens displaying Addresses 1 -31. To select one or more addresses for the installed ACS annunciator(s), press the number key corresponding to the address in each screen. The display for the selected address will change from *No* to *Yes*. Each press of the number key will cause the display to toggle between *No* and *Yes*.



Option Module Screen

3.6.9.2 Onboard DACT

The Onboard DACT (Digital Alarm Communicator/Transmitter) provides communication to a central station. Pressing *2* while viewing the Option Module Screen will cause the following screens to be displayed:



On Board DACT Screen #1

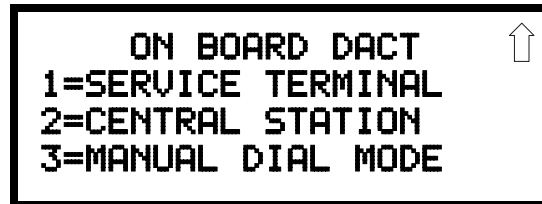

On Board DACT Screen #2

3.6.9.2.1 Onboard DACT Enable

To enable the onboard DACT, press *1* while viewing Onboard DACT Screen #1 until the display reads *Enabled Yes*. The display will toggle between *Enabled Yes* and *Enabled No* with each press of the key.

3.6.9.2.2 Primary Phone

Press 2 while viewing On Board DACT Screen #1 to program the type of primary phone line being connected to the DACT. The following screen will be displayed:

```

ON BOARD DACT
PRIMARY PHONE LINE
1=TYPE      TOUCHTONE
  
```

Primary Phone Line Screen

To select the type, press 1 while viewing the Primary Phone Line screen. The following screen will be displayed:

```

PHONE LINE
1=TOUCHTONE
2=ROTARY 67/33
3=ROTARY 62/38
  
```

Primary Phone Type Screen

Press 1 to select Touchtone dialing, 2 to select Rotary dialing with a make/break ratio of 67/33 or 3 to select Rotary dialing with a make/break ratio of 62/38.

3.6.9.2.3 Secondary Phone

Press 3 while viewing On Board DACT Screen #1 to program the type of secondary phone line being connected to the DACT. The following screen will be displayed:

```

ON BOARD DACT
1=ENABLED
2=PRIMARY PHONE
3=SECONDARY PHONE
  
```

On Board DACT Screen #1

```

ON BOARD DACT
SECONDARY PHONE LINE
1=TYPE      TOUCHTONE
  
```

Secondary Phone Line Screen

To select the type, press 1 while viewing the Secondary Phone Line screen. The following screen will be displayed:

```

PHONE LINE
1=TOUCHTONE
2=ROTARY 67/33
3=ROTARY 62/38
  
```

Secondary Phone Type Screen

Press 1 to select Touchtone dialing, 2 to select Rotary dialing with a make/break ratio of 67/33 or 3 to select Rotary dialing with a make/break ratio of 62/38.

ON BOARD DACT
1=SERVICE TERMINAL
2=CENTRAL STATION
3=MANUAL DIAL MODE

On Board DACT Screen #2

3.6.9.2.4 Service Terminal

The MS-9200UD can be programmed remotely from a PC using a modem and telephone line. Information can also be retrieved from the FACP using the same method. The Upload/Download option allows an operator to set the necessary parameters to allow the uploading and downloading of data between the FACP and PC. The Service Terminal selection provides the means for entering these parameters.

Pressing *1* while viewing On Board DACT Screen #2 will cause the following screens to appear:

SERVICE TERMINAL ↓
1=PANEL ID **0000**
2=TERMINAL 1
3=TERMINAL 2

Service Terminal Screen #1

SERVICE TERMINAL ↑
1=RING COUNT **3**

Service Terminal Screen #2

3.6.9.2.4.1 Panel ID

The Panel Identification Number is a 4-digit code (valid digits being 0 - 9 and A - F) that is used to identify the installed FACP. It is important to program this code into the FACP the first time that downloading is performed so that the called Service Terminal can identify the control panel. The factory default is *0000*.

To program the Panel ID, press *1* while viewing Service Terminal Screen #1. The following screen will be displayed:

PANEL ID
4 CHARACTER 0-F
 █

Panel ID Screen

A flashing cursor will appear in the lower left corner of the display. Enter a 4-digit code using the digits 0 - 9 and/or the letters A - F by entering the first character. Press the right arrow key to move the cursor to the second position and enter the second character. Follow the same procedure to enter the remaining characters. After entering the fourth character, press the right arrow key and then press the Enter key to store the Panel ID number.

```

SERVICE TERMINAL
1= PANEL ID
2= TERMINAL 1
3= TERMINAL 2

```

Service Terminal Screen #1

3.6.9.2.4.2 Terminal 1 and Terminal 2

Service Terminal #1 is generally designated as the FACP primary phone line used for receiving phone calls from the service terminal (PC) being used for remote programming. Service Terminal 2 is referred to as the secondary phone line. Pressing 2 for Terminal 1 or 3 for Terminal 2 while viewing Service Terminal Screen #1 will display the following screen:

```

SERVICE TERMINAL #
1=PHONE NUMBER

```

Service Terminal # Screen

Phone Number (Service Terminal)

The Service Terminal Phone Number will be used by the control panel to contact the service terminal. Pressing 1 while viewing the Service Terminal # Screen will cause the following screen to be displayed:

```

PHONE NUMBER
20 NUMBERS MAXIMUM

```

Printer-PC Screen

A flashing cursor will appear in the lower left corner. Enter the phone number for the service terminal by keying in the first digit, pressing the left arrow key and entering the second digit. Continue this process until all desired numbers have been entered (maximum of 20 characters). Press the *Enter* key to store the phone number in memory and return the display to the Service Terminal # Screen.

Valid entries are 0 - 9 and A - F with the numeric digits as dialed numbers and letters representing the following functions:

- A = * on a Touchtone phone keypad
- B = # on a Touchtone phone keypad
- C = look for secondary dial tone for up to two seconds (then dial anyway)
- D = three second pause
- E = five second pause
- F = end of phone number (F is automatically entered for unused entry positions)

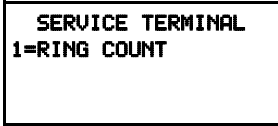

Service Terminal Screen #2

3.6.9.2.4.3 Ring Count

The ring count designates the number of rings allowed on the phone line prior to answering an incoming call from a service terminal. The factory default is 3 which means the control panel will not answer an incoming call until 3 rings are detected. This entry may be programmed for 1 to 25 rings. A setting of 00 prevents the panel from answering incoming calls.

To change the Ring Count, press 1 while viewing the Service Terminal Screen #2. The following screen will be displayed:



Ring Count Screen

A flashing cursor will appear in the lower left corner of the display. Enter the two-digit ring count which can be a value between 00 and 25. After the second digit is entered, the display will return to the Service Terminal screen.

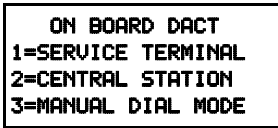

On Board DACT Screen #2

3.6.9.2.5 Central Station

Central Station programming configures the control panel DACT for contacting the central station. Pressing 2 while viewing On Board DACT Screen #2 will cause the following screens to be displayed:



Central Station Screen #1



Central Station Screen #2

3.6.9.2.5.1 Reporting Enable

To enable the DACT for reporting FACP activity to the central station, press 1 while viewing Central Station Screen #1 so the display reads *Reporting Enabled*. Each press of the 1 key will toggle the display between *Reporting Disabled* and *Reporting Enabled*.

3.6.9.2.5.2 Backup Reporting

The DACT can be programmed to transmit reports to primary and/or secondary central station phone numbers as a backup. Press 2 while viewing Central Station Screen #1 to display the following screen:

```
BACKUP REPORTING
1=BACKUP ONLY
2=BOTH
3=FIRST AVAILABLE
```

Backup Reporting Screen

Press 1 to have all reports transmitted to the central station secondary phone number as a backup only if the primary phone line fails, 2 to transmit all reports to both the primary and secondary phone numbers all of the time or 3 to send reports to the first available phone number.

3.6.9.2.6 Trouble Call Limit (Dialer Runaway Prevention)

The Call Limit option limits the number of DACT trouble calls to the Central Station, to a programmed amount between 0 and 99, for each unique trouble within a 24 hour period. Separate limit counters keep track of each unique type of trouble. Note that the number of phone line (communication) faults called to the Central Station are not limited by this feature. No subsequent restoral message is sent to the Central Station(s) for a particular trouble whose call limit has been reached. Local DACT annunciation will still track the particular trouble and restoral.

To set the Trouble Call Limit, press 3 while viewing Central Station Screen #1. The following screen will be displayed.

```
TRouble CALL LIMIT
00-99 RANGE
*
```

Backup Reporting Screen

Enter a value between 00 and 99, then press Enter to set the Call Limit to this value.

CENTRAL STATION
1=PRIMARY
2=SECONDARY
3=REPORT STYLE

Central Station Screen #2

3.6.9.2.6.1 Central Station Primary and Secondary Phone Numbers

Pressing 1 for Primary or 2 for Secondary will display the following screens.

Note that the following information must be entered for both the Primary and Secondary Central Station Phone Numbers.

CENTRAL STATION # 
1=TEST TIME INT 24
2=ACCOUNT CODE 0000
3=24HR TST TIME 0021

Primary/Secondary Screen #1

CENTRAL STATION 
1=PHONE NUMBER

Primary/Secondary Screen #2

CENTRAL STATION 
1=COMM FORMAT
ADEMCO-CONTACT-ID

Primary/Secondary Screen #3

CENTRAL STATION 
1=EVENT CODES

Primary/Secondary Screen #4

```

CENTRAL STATION
1=TEST TIME INT
2=ACCOUNT CODE
3=24HR TST TIME

```

Primary/Secondary Screen #1

Test Time Interval

Pressing 1 while viewing Primary/Secondary Screen #1 will cause the following screens to be displayed:

```

TEST TIME INTERVAL ↓
1=24 HOURS
2=12 HOURS
3=8 HOURS

```

Test Time Interval Screen #1

```

TEST TIME INTERVAL ↑
1=6 HOURS

```

Test Time Interval Screen #2

The test report sent to the Central Station phone number may be sent once every 6, 8, 12 or 24 hours. Select the desired Test Time Interval by pressing the corresponding digit in the screens shown above.

Account Code

Pressing 2 while viewing Primary/Secondary Screen #1 will cause the following screen to be displayed:

```

ACCOUNT CODE
4 CHAR RANGE 0-F
█

```

Account Codes Screen

The Account Code, which is assigned by a Central Station, depends on the communication format being used. The Account Code screen will have a flashing cursor in the lower left corner. Enter the supplied account code using 0 - 9 and A- F keys.

CENTRAL STATION
1=TEST TIME INT
2=ACCOUNT CODE
3=24HR TST TIME

Primary/Secondary Screen #1

24 Hour Test Time

Pressing 3 while viewing Primary/Secondary Screen #1 will cause the following screen to be displayed:

24 HOUR TEST TIME
RANGE 0000-2359
 █

24 Hour Test Time Screen

Use the 24 Hour Test Time screen to program the time that the DACT will transmit the 24 Hour Test to the Central Station. A flashing cursor will appear in the lower left corner of the screen. Enter a four digit number representing the test time using military time (0000 = midnight and 2359 = 11:59PM).

CENTRAL STATION
1=PHONE NUMBER

Primary/Secondary Screen #2

Phone Number

Pressing 1 while viewing Primary/Secondary Screen #2 will cause the following screen to be displayed:

PHONE NUMBER
20 NUMBERS MAXIMUM
 █

Phone Number Screen

The Phone Number screen is used to enter the Central Station phone number that the DACT will be contacting. A maximum of 20 characters can be entered with valid entries being 0 - 9 and A - F where A = *, B = #, C = look for secondary dial tone for up to 2 seconds (then dial anyway), D = 3 second pause, E = 5 second pause and F = end of phone number (must be entered at end of phone number).

A flashing cursor will appear in the lower left corner of the screen. Enter the first digit then press the right arrow key to move the cursor to the right one position. Enter the second digit and repeat the process until all digits are entered. Press the *Enter* key to store the phone number in memory.

Enter the digits as you would like the number to be dialed. For example, if it's necessary to dial 9 before dialing a number outside the building, you may wish to pause after dialing 9. Enter 9 followed by *D* for a three second pause or *E* for a five second pause then the phone number followed by an F to indicate the end of the number.

CENTRAL STATION
1=COMM FORMAT

Primary/Secondary Screen #3

Communication Format

Pressing 1 while viewing Primary/Secondary Screen #3 will cause the following screens to be displayed:

COMM FORMAT
1=ADEMCO EXPRESS 4P1
2=ADEMCO EXPRESS 4P2
3=3P1S C18 A23

Comm Format Screen #1

COMM FORMAT
1=3P1E C18 A23
2=3P1S C19 A14
3=3P1E C19 A14

Comm Format Screen #2

COMM FORMAT
1=4P1S C18 A23
2=4P1E C18 A23
3=4P1S C19 A14

Comm Format Screen #3

COMM FORMAT
1=4P1E C19 A14
2=4P2S C18 A23
3=4P2E C18 A23

Comm Format Screen #4

COMM FORMAT
1=4P2S C19 A14
2=4P2E C19 A14
3=ADEMCO CONTACT ID

Comm Format Screen #5

The Communication Format is determined by the type of receiver that the DACT is transmitting to. Consult your Central Station for proper selection or consult our factory representatives. For any format chosen, the control panel automatically programs all of the event codes.

Select the Communication Format by pressing the corresponding number key while viewing the appropriate Comm Format screen. The following table describes each format:

Table 3.1 Communication Formats

Screen Selection	Communication Format Description
ADEMCO EXPRESS 4P1	4+1 Ademco Express Standard, DTMF, 1400/2300 ACK
ADEMCO EXPRESS 4P2	4+2 Ademco Express Standard, DTMF, 1400/2300 ACK
3P1S C18 A23	3+1 Standard 1800 Hz Carrier, 2300 Hz ACK
3P1E C18 A23	3+1 Expanded 1800 Hz Carrier, 2300 Hz ACK
3P1S C19 A14	3+1 Standard 1900 Hz Carrier, 1400 Hz ACK
3P1E C19 A14	3+1 Expanded 1900 Hz Carrier, 1400 Hz ACK
4P1S C18 A23	4+1 Standard 1800 Hz Carrier, 2300 Hz ACK
4P1E C18 A23	4+1 Expanded 1800 Hz Carrier, 2300 Hz ACK
4P1S C19 A14	4+1 Standard 1900 Hz Carrier, 1400 Hz ACK
4P1E C19 A14	4+1 Expanded 1900 Hz Carrier, 1400 Hz ACK
4P2S C18 A23	4+2 Standard 1800 Hz Carrier, 2300 Hz ACK
4P2E C18 A23	4+2 Expanded 1800 Hz Carrier, 2300 Hz ACK
4P2S C19 A14	4+2 Standard 1900 Hz Carrier, 1400 Hz ACK
4P2E C19 A14	4+2 Expanded 1900 Hz Carrier, 1400 Hz ACK
ADEMCO CONTACT ID	Contact ID, DTMF, 1400/2300 ACK

CENTRAL STATION
1=EVENT CODES

Primary/Secondary Screen #4

Event Codes

Pressing 1 while viewing Primary/Secondary Screen #4 will cause the following screen to be displayed:

EVENT CODES
1=PULL STATION
2=MON-USER-DEF-1
3=WATERFLOW

Event Code Screen

Pressing the down arrow key allows viewing of all Events associated with the selected Communication Format. Pressing the number corresponding to the event displayed in each screen will display its default event code which can be customized by the programmer. For example, pressing 1 for Pull Station will display the following screen which allows the Event Code to be changed from the default value.

PULL STATION
ALARM **000**

Event Code Screen

The tables on the following pages list all of the Events and their default Event Codes for the various Communication Formats.

3+1, 4+1 Express and 4+1 Standard

The information shown in Table 3.2 is automatically programmed for the Central Station phone number Event Codes when any of these Formats are selected. Enter 0 for an Event Code Setting to disable the report.

Table 3.2 Event Codes

Event Description	Event Code Settings	
	Active	Restoral
PULL STATION	1	E
MON-USER-DEF-1	1	E
WATERFLOW	1	E
MON-USER-DEF-2	1	E
SMOKE (PHOTO)	1	E
DET-USER-DEF-1	1	E
SMOKE (ION)	1	E
DET-USER-DEF-2	1	E
HEAT DETECT	1	E
DET-USER-DEF-3	1	E
SMOKE DUCT-P	1	E
DET-USER-DEF-4	1	E
DUCT SUPERVISORY	8	E
DET-USER-DEF-5	8	E
not used	0	0
not used	0	0
not used	0	0
not used	0	0
MONITOR	1	E
MON-USER-DEF-3	1	E
not used	0	0
not used	0	0
SMOKE CONVEN	1	E
MON-USER-DEF-5	1	E
HEAT DETECT	1	E
MON-USER-DEF-6	1	E
MEDIC ALERT	0	0
MON-USER-DEF-7	0	0
HAZARD ALERT	0	0
MON-USER-DEF-8	0	0
TORNADO ALRT	0	0
MON-USER-DEF-9	0	0
not used	0	0
not used	0	0
TAMPER	8	E
MON-USER-DEF-11	8	E
MON SUPERVISORY	8	E
MON-USER-DEF-12	8	E
MON SUPERV AUTO	8	E
MON-USER-DEF-13	8	E
POWER MON	6	A
MON-USER-DEF-14	6	A
TROUBLE MON	refer to POINT_FAULT for codes	
MON-USER-DEF-15	refer to POINT_FAULT for codes	
PROCESS MON	0	0

Table 3.2 Event Codes (continued)

MON-USER-DEF-16	0	0
PROCMON AR	0	0
MON-USER-DEF-17	0	0
not used	0	0
not used	0	0
POINT_FAULT	F	D
POINT_DISABLE	4	5
AC_FAIL	9	3
DRILL	B	C
SLC OPEN FAULT	6	A
SLC SHORT FAULT	6	A
not used	0	0
not used	0	0
GROUND FAULT	6	A
LOW BATTERY	6	A
NO_BATTERY	6	A
TELCO LINE 1	6	A
TELCO LINE 2	6	A
COMM FAULT 1	6	A
COMM FAULT 2	6	A
TOTAL COMM FLT	0	0
PRINTER FAULT	6	A
NAC 1 FAULT	6	A
NAC 2 FAULT	6	A
NAC 3 FAULT	6	A
NAC 4 FAULT	6	A
not used	0	0
VOICE EVACUATION	6	A
ACS FAULT	6	A
LCD_80F FAULT	6	A
NAC 1 DISABLE	4	5
NAC 2 DISABLE	4	5
NAC 3 DISABLE	4	5
NAC 4 DISABLE	4	5
MEMORY FAULT	6	A
CHARGER FAULT	6	A
OPTION CARD 1 FAULT	6	A
REMOTE SYNC FAULT	6	A
not used	0	0
ZONE DISABLE	4	5
NAC_KEY_FLT	6	A
NO_DEVICES_INSTLLD	6	A
OFF_NORMAL_MESSAGE	6	A
24_HOUR_TEST	9	0
24 HOUR ABNORMAL TES	F	0
UPDOWN REQUEST	7	0
UPLOAD SUCCESS	7	0
DOWNLOAD SUCCESS	7	0
UPDOWN FAILURE	7	0
GENERAL_ALARM	1	E
GENERAL_SUPERVISORY	8	E

4+2 Standard, 4+2 Express, 3 + 1, 4 + 1 and 4+2 Expanded Formats

The information shown in Table 3.3 is automatically programmed for the Central Station phone number Event Codes when any of these Formats are selected. Enter 00 for an Event Code Setting to disable the report.

Table 3.3 Event Codes

Event Description	Event Code Settings	
	Active	Restoral
PULL STATION	11	E1
MON-USER-DEF-1	11	E1
WATERFLOW	11	E1
MON-USER-DEF-2	11	E1
SMOKE (PHOTO)	11	E1
DET-USER-DEF-1	11	E1
SMOKE (ION)	11	E1
DET-USER-DEF-2	11	E1
HEAT DETECT	11	E1
DET-USER-DEF-3	11	E1
SMOKE DUCT-P	11	E1
DET-USER-DEF-4	11	E1
DUCT SUPERVISORY	81	E1
DET-USER-DEF-5	81	E1
not used	00	00
not used	00	00
not used	00	00
not used	00	00
MONITOR	11	E1
MON-USER-DEF-3	11	E1
not used	00	00
not used	00	00
SMOKE CONVEN	11	E1
MON-USER-DEF-5	11	E1
HEAT DETECT	11	E1
MON-USER-DEF-6	11	E1
MEDIC ALERT	00	00
MON-USER-DEF-7	00	00
HAZARD ALERT	00	00
MON-USER-DEF-8	00	00
TORNADO ALRT	00	00
MON-USER-DEF-9	00	00
not used	00	00
not used	00	00
TAMPER	81	E1
MON-USER-DEF-11	81	E1
MON SUPERVISORY	81	E1
MON-USER-DEF-12	81	E1
MON SUPERV AUTO	81	E1
MON-USER-DEF-13	81	E1
POWER MON	81	E1
MON-USER-DEF-14	81	E1
TROUBLE MON	refer to POINT_FAULT for codes	
MON-USER-DEF-15	refer to POINT_FAULT for codes	
PROCESS MON	00	00

Table 3.3 Event Codes (continued)

MON-USER-DEF-16	00	00
PROCMON AR	00	00
MON-USER-DEF-17	00	00
not used	00	00
not used	00	00
POINT_FAULT	F1	D1
POINT_DISABLE	41	51
AC_FAIL	92	93
DRILL	97	98
SLC OPEN FAULT	43	53
SLC SHORT FAULT	44	54
not used	00	00
not used	00	00
GROUND FAULT	61	A1
LOW BATTERY	62	A2
NO_BATTERY	63	A3
TELCO LINE 1	64	A4
TELCO LINE 2	65	A5
COMM FAULT 1	6A	AA
COMM FAULT 2	6B	AB
TOTAL COMM FLT	00	00
PRINTER FAULT	6C	AC
NAC 1 FAULT	66	A6
NAC 2 FAULT	67	A7
NAC 3 FAULT	68	A8
NAC 4 FAULT	69	A9
not used	00	00
VOICE EVACUATION	00	00
ACS FAULT	6D	AD
LCD_80F FAULT	6E	AE
NAC 1 DISABLE	4B	5B
NAC 2 DISABLE	4C	5C
NAC 3 DISABLE	4D	5D
NAC 4 DISABLE	4E	5E
MEMORY FAULT	46	56
CHARGER FAULT	47	57
OPTION CARD 1 FAULT	48	58
REMOTE SYNC FAULT	49	59
not used	00	00
ZONE DISABLE	42	52
NAC_KEY_FLT	4B	5B
NO_DEVICES_INSTLLD	4A	5A
OFF_NORMAL_MESSAGE	6F	AF
24_HOUR_TEST	99	00
24 HOUR ABNORMAL TES	FB	00
UPDOWN REQUEST	71	00
UPLOAD SUCCESS	72	00
DOWNLOAD SUCCESS	73	00
UPDOWN FAILURE	74	00
GENERAL_ALARM	11	E1
GENERAL_SUPERVISORY	81	E2

Ademco Contact ID Format

The information shown in Table 3.4 is automatically programmed for the Central Station phone number Event Codes when Ademco Contact ID Format is selected. Enter 000 for an Event Code Setting to disable the report.

Table 3.4 Event Codes

Event Description	Event Code Settings Active
PULL STATION	115
MON-USER-DEF-1	115
WATERFLOW	113
MON-USER-DEF-2	113
SMOKE (PHOTO)	111
DET-USER-DEF-1	111
SMOKE (ION)	111
DET-USER-DEF-2	111
HEAT DETECT	114
DET-USER-DEF-3	114
SMOKE DUCT-P	116
DET-USER-DEF-4	116
DUCT SUPERVISORY	200
DET-USER-DEF-5	200
not used	000
not used	000
not used	000
not used	000
MONITOR	110
MON-USER-DEF-3	110
not used	000
not used	000
SMOKE CONVEN	111
MON-USER-DEF-5	111
HEAT DETECT	114
MON-USER-DEF-6	114
MEDIC ALERT	100
MON-USER-DEF-7	100
HAZARD ALERT	150
MON-USER-DEF-8	150
TORNADO ALRT	150
MON-USER-DEF-9	150
not used	000
not used	000
TAMPER	144
MON-USER-DEF-11	144
MON SUPERVISORY	200
MON-USER-DEF-12	200
MON SUPERV AUTO	200
MON-USER-DEF-13	200
POWER MON	330
MON-USER-DEF-14	330
TROUBLE MON	refer to POINT_FAULT for code
MON-USER-DEF-15	refer to POINT_FAULT for code
PROCESS MON	000

Table 3.4 Event Codes (continued)

MON-USER-DEF-16	000
PROCMON AR	000
MON-USER-DEF-17	000
not used	000
not used	000
POINT_FAULT	380
POINT_DISABLE	570
AC_FAIL	301
DRILL	604
SLC OPEN FAULT	371
SLC SHORT FAULT	372
not used	000
not used	000
GROUND FAULT	310
LOW BATTERY	302
NO_BATTERY	311
TELCO LINE 1	351
TELCO LINE 2	352
COMM FAULT 1	354
COMM FAULT 2	355
TOTAL COMM FLT	000
PRINTER FAULT	336
NAC 1 FAULT	321
NAC 2 FAULT	322
NAC 3 FAULT	326
NAC 4 FAULT	327
not used	000
VOICE EVACUATION	337
ACS FAULT	333
LCD_80F FAULT	334
NAC 1 DISABLE	521
NAC 2 DISABLE	522
NAC 3 DISABLE	526
NAC 4 DISABLE	527
MEMORY FAULT	304
CHARGER FAULT	300
OPTION CARD 1 FAULT	331
REMOTE SYNC FAULT	332
not used	000
ZONE DISABLE	570
NAC_KEY_FLT	300
NO_DEVICES_INSTLLD	380
OFF_NORMAL_MESSAGE	308
24_HOUR_TEST	602
24 HOUR ABNORMAL TES	608
UPDOWN REQUEST	411
UPLOAD SUCCESS	416
DOWNLOAD SUCCESS	412
UPDOWN FAILURE	413
GENERAL_ALARM	110
GENERAL_SUPERVISORY	200

```

CENTRAL STATION
1=PRIMARY
2=SECONDARY
3=REPORT STYLE POINT

```

Central Station Screen #2

Report Style

Pressing 3 while viewing Central Station Screen #2 will cause the Report Style display to toggle between *Point* and *Zone*. Setting the Report Style to Point will program the DACT to report individual point status to the Central Station. The control panel is capable of monitoring a total of 198 addressable devices. Setting the Report Style to Zone will program the DACT to report zone status to the Central Station. The control panel is capable of monitoring a total of 99 individual zones.

Notes:

1. Detector Address 01 will be reported to the Central Station as Point 01, Detector Address 02 as Point 02, with reports continuing in a similar fashion all the way up to Detector Address 99 which will be reported as Point 99.
2. Module Address 01 will be reported to the Central Station as Point 160, Module Address 02 will be reported to the Central Station as Point 161, with reports continuing in a similar fashion all the way up to Module Address 99 which will be reported as Point 258.

```

ON BOARD DACT
1=SERVICE TERMINAL
2=CENTRAL STATION
3=MANUAL DIAL MODE

```

On Board DACT Screen #2

3.6.9.2.7 Manual Dial Mode

Pressing 3 while viewing On Board DACT Screen #2 will cause the following screen to be displayed:

```

MANUAL DIAL MODE
1=PRIMARY PHONE
2=SECONDARY PHONE

```

Pressing 1 for Primary Phone or 2 for Secondary Phone will display the following screen:

```

MANUAL DIAL MODE
1=GO OFF HOOK
2=DIAL DIGIT(S)
3=GO ON HOOK

```

Pressing 1 for Go Off Hook will cause the DACT to access the selected phone line (similar to taking the phone handset off the cradle). The selected phone line's red Active LED will turn on.

Pressing 2 for Dial Digit(s) will display a screen which allows the user to key in the phone number to be dialed. The first digit is keyed in and then the right arrow key is pressed to move the cursor to the next position. The next digit is keyed in and the process is repeated until all digits have been entered. Pressing the *Enter* key will cause the number just entered to be dialed.

Pressing 3 for Go On Hook will cause the DACT to hang-up, deselecting the previously selected phone line. The phone line's red Active LED will turn off.

```

OPTION MODULES
1=ANNUNCIATORS/UDACT
2=ON BOARD DACT
3=PRINTER/PC  NO

```

Option Module Screen

3.6.9.3 Printer/PC

A Printer or a PC can be connected to the control panel. Pressing 3 while viewing the Option Module Screen will cause the following screen to appear:

```

PRINTER-PC
1=PRINTER NO SU  NO
2=PRINTER SU    YES
3=PC            NO

```

Printer-PC Screen

Pressing 1 while viewing the Printer-PC Screen will program the control panel for an unsupervised (*NO SU*) printer. The display will change to the Printer Baud Rate Screen as shown below.

Pressing 2 while viewing the Printer-PC Screen will program the control panel for a supervised (*SU*) printer. Printer supervision, when enabled, will typically detect the removal of the printer cable and will detect when the printer power has been turned off. Depending upon the brand of printer, other errors such as paper empty or printer off-line may be detected.

The following screen will appear, which allows the programmer to select the baud rate for the printer communication:

```

PRINTER BAUD RATE
1=2400 BAUD
2=4800 BAUD
3=9600 BAUD

```

Printer Baud Rate Screen

Pressing the number key corresponding to the desired baud rate (2 for 4800 Baud for example) will program the control panel for the selected baud rate and return the display to the Option Module Screen which will indicate *Printer/PC PR4800* for a supervised printer installed at 4800 baud rate.

Pressing 3 while viewing the Printer-PC Screen will program the control panel for a PC connection. The display will return to the Option Module Screen which will indicate *Printer/PC PC* for personal computer installed.

Note: The LCD-80F and the Printer/PC use the same TB8 terminal block. Only one device can be used at any one time. Setting any option in the Printer/PC screen to Yes will disable communications with the LCD-80F. The printer must be installed in the same room and within 50 feet of the FACP.

3.6.10 Password Change

PROGRAMMING
1=PASSWORD CHANGE
2=CLEAR PROGRAM
3=PROGRAM CHECK

Programming Screen #4

The factory set passwords, which have been programmed into the control panel, can be changed by selecting the Password Change option. Pressing *1* while viewing Programming Screen #4 will cause the following screen to be displayed:

PASSWORD CHANGE
1=MASTER
2=MAINTENANCE

Password Change Screen

Press *1* to change the Master Programming Level password or *2* to change the Maintenance Level password. *Note that the passwords will not be displayed on LCD-80F annunciators.*

The following screen will appear when either change option is selected:

ENTER NEW FIVE DIGIT
PASSWORD

Enter Password Screen

A flashing cursor will appear in the center of the display. Enter a new five digit password (such as 10101 for the Master Level). After the fifth digit is entered, the following screen will be displayed:

NEW MASTER
PASSWORD IS 10101
PRESS ENTER IF OK

Password Change Screen

Pressing the *Enter* key will program the new password into the control panel and return the display to the Password Change Screen.

3.6.11 Clear Program

PROGRAMMING
1=PASSWORD CHANGE
2=CLEAR PROGRAM
3=PROGRAM CHECK

Programming Screen #4

Pressing 2 while viewing Programming Screen #4, will select the Clear Program option. This will cause the LCD to display the following screen:

CLEAR PROGRAM
1=WHOLE SYSTEM
2=ALL POINTS

Clear Program Screen #1

Pressing 1, for Whole System while viewing the Clear Program Screen #1, will clear all general system programming options and all programmed addressable devices from the nonvolatile memory of the FACP. *This function is useful when the control panel is first installed, prior to autoprogramming. Note that it is necessary to autoprogram after using the Clear Whole System function.*



See Page

Pressing 2, for ALL POINTS while viewing the Clear Program Screen #1, will clear all programming related to the SLC loop and connected addressable devices.

Before executing any of the Clear commands listed above, the control panel will provide a warning to the user by prompting with the following display:

WARNING!
SYSTEM CHANGE
PROCEED?
1=YES **2=NO**

Pressing 1 will cause the control panel to carry out the selected clear option. Pressing 2 will prevent programming from being cleared.

3.6.12 Program Check

PROGRAMMING
1=PASSWORD CHANGE
2=CLEAR PROGRAM
3=PROGRAM CHECK

Programming Screen #4

The Program Check feature allows the programmer to view the zones which have been programmed to the Notification Appliance Circuits on the control panel but have not been programmed to Initiating Devices as well as other circuits with no input or output correlations. Pressing 3 while viewing Programming Screen #4 will cause the following screen to be displayed:

PROGRAMCHECK
1=NACS NO INPUT
2=ZONES NO INPUT
3=ZONES NO OUTPUT

PROGRAMCHECK
1=NACS NO INPUT
2=ZONES NO INPUT
3=ZONES NO OUTPUT

Program Check Screen

Pressing 1 while viewing the Program Check screen will display an NAC screen similar to the following.

NACS NO INPUT
NAC 1
25 31 44 55 67

The example above indicates that NAC 1 has been programmed to Zones 25, 31, 44, 55 and 67 but no input devices have been programmed to any of these zones. Use the up and down arrow keys to view all the NAC zones without input assignments for NAC 1, NAC2, NAC 3 and NAC 4.

Note: If the NACs have been configured for Class A in the Setup option, only NAC1 and NAC 2 will display test information. NAC 3 and NAC 4 will display asterisks () and will not be included in the test.*

Pressing 2 while viewing the Program Check screen will display a screen similar to the following:



The Zone No Input screen allows the programmer to view the zones which have not been programmed to at least one input device (not including general alarm Zone 00). The example in the preceding screen indicates that Zones 05, 07, 09, 10 and 11 have been programmed to an addressable module (control module in this example) with an address of 001 on loop 1 but have not been programmed to any input devices. Use the up and down arrow keys to view all the zones without input assignments.

Pressing 3 while viewing Program Check screen will cause a screen similar to the following to be displayed:

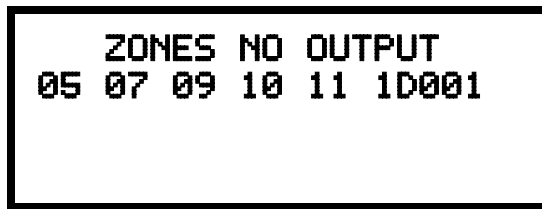

The Zone No Output feature allows the programmer to view the zones which have not been programmed to at least one output device (not including general alarm Zone 00). The example in the preceding screen indicates that Zones 05, 07, 09, 10 and 11 have been programmed to an addressable detector with an address of 001 on loop 1 but have not been programmed to any output devices. Use the up and down arrow keys to view all the zones without output assignments.

3.7 Maintenance Programming Level

To access Maintenance Programming mode, press the *Enter* key. The LCD will display the following:

```
1=READ STATUS
2=PROGRAMMING
```

To enter the Maintenance Programming mode, press 2. The display will read as follows:

```
PROGRAMMING
ENTER PASSWORD
```

When the *Maintenance* level password (default *1111*) is entered, the following screen will appear:

```
PROGRAMMING
1=POINT PROGRAM
2=HISTORY
3=PROGRAM CHECK
```



Note that in the preceding screens, an arrow appears to inform the programmer that additional options can be viewed by pressing the keypad *down* arrow key, as shown in the following screen.

```
PROGRAMMING
1=WALKTEST
2=SYSTEM
3=ZONE SETUP
```



3.7.1 Disable Point

```
PROGRAMMING
1=POINT PROGRAM
2=HISTORY
3=PROGRAM CHECK
```

Maintenance Screen #1

Pressing *1* for Point Program, while viewing Maintenance Screen #1 will cause the following screens to be displayed:

```
POINT PROGRAM
1=DETECTOR
2=MODULE
```

Device Select Screen

Select the device type by pressing *1* for an addressable detector or *2* for an addressable module. The operator will be prompted to enter the three digit device address as shown in the following example for a detector:

```
EDIT DETECTOR
ENTER POINT ADDRESS
**
```

Address Select Screen

A flashing cursor will appear in the bottom left corner of the display, prompting for the three digit device address. When the third digit is enter, *001* for example, a screen will appear which will allow enabling or disabling of the selected point, as illustrated in the following example:

```
EDIT DETECTOR 1001
1=ENABLED      YES
```

Enable/Disable Select Screen

Pressing *1* repeatedly will cause the display to toggle between *Enabled Yes* and *Enabled No*.

3.7.2 History

```

PROGRAMMING
1=POINT PROGRAM
2=HISTORY
3=PROGRAM CHECK

```

Maintenance Screen #1

Pressing 2 while viewing Maintenance Screen #1 will cause the following screen to be displayed:

```

HISTORY
1=VIEW EVENTS
2=ERASE HISTORY

```

History Screen

The History feature allows the operator to view control panel events which have been stored in a history file in memory and erase the contents of the history file

Pressing 1 while viewing the History screen will cause the following screen to be displayed:

```

HISTORY
1=VIEW ALL
2=VIEW ALARMS
3=VIEW OTHER EVENTS

```

Events Screen

To view all the events which have occurred in the control panel since the history file was last erased, press 1 while viewing the Events screen. To view only alarms which have occurred, press 2 while viewing the Events screen. To view events other than alarms, press 3. The most recent event will be displayed on the screen. To view all of the selected events, press the up or down arrow keys to scroll through the list of events. If no events have occurred, the display will read *NO EVENTS IN HISTORY*.

Pressing 2 while viewing the History Screen will cause the following screen to be displayed:

```

ERASE HISTORY
PROCEED ?
1=YES          2=NO

```

Erase History Screen

Pressing 1 while viewing the Erase History Screen will cause the message *ERASING HISTORY, PLEASE WAIT* to be displayed. The display will then return to the History Screen. Pressing 2 will cause the display to return to the History Screen without erasing the History file.

3.7.3 Program Check

PROGRAMMING
1=POINT PROGRAM
2=HISTORY
3=PROGRAM CHECK

Maintenance Screen #1

Pressing 3 while viewing Maintenance Screen #1 will cause the following screen to be displayed:

PROGRAMCHECK
1=NACS NO INPUT
2=ZONES NO INPUT
3=ZONE NO OUTPUT

Program Check Screen

The Program Check feature allows the programmer to view the zones which have been programmed to the Notification Appliance Circuits on the control panel but have not been programmed to Initiating Devices as well as other circuits with no input or output correlations. Pressing 1 while viewing Program Check screen will cause a screen similar to the following to be displayed.

NACS NO INPUT
NAC 1
25 31 44 55 67

The example above indicates that NAC 1 has been programmed to Zones 25, 31, 44, 55 and 67 but no input devices have been programmed to any of these zones. Use the up and down arrow keys to view all the NAC zones without input assignments for both NAC 1, NAC 2, NAC 3 and NAC 4.

Note: If the NACs have been configured for Class A in the Setup option, only NAC 1 and NAC 2 will display test information. NAC 3 and NAC 4 will display asterisks () and will not be included in the test.*

Pressing 2 while viewing the Program Check screen will display a screen similar to the following:

ZONES NO INPUT
05 07 09 10 11 1M001

The Zone No Input screen allows the programmer to view the zones which have not been programmed to at least one input device (not including general alarm Zone 00). The example in the preceding screen indicates that Zones 05, 07, 09, 10 and 11 have been programmed to an addressable module (control module in this example) with an address of 001 on loop 1 but have not been programmed to any input devices. Use the up and down arrow keys to view all the zones without input assignments.

Pressing 3 while viewing Program Check screen will cause a screen similar to the following to be displayed:

```

ZONES NO OUTPUT
05 07 09 10 11 1D001

```

The Zone No Output feature allows the programmer to view the zones which have not been programmed to at least one output device (not including general alarm Zone 00). The example in the preceding screen indicates that Zones 05, 07, 09, 10 and 11 have been programmed to an addressable detector with an address of 001 on loop 1 but have not been programmed to any output devices. Use the up and down arrow keys to view all the zones without output assignments.

3.7.4 Walktest

```

PROGRAMMING
1=WALKTEST
2=SYSTEM
3=ZONE SETUP

```

Maintenance Screen #2

To perform a walktest, press 1 while viewing Maintenance Screen #2. The following screen will be displayed:

```

WALKTEST
1=SILENT
2=AUDIBLE
3=VIEW RESULT

```

Walktest Screen

The operator can press 1 to perform a silent walktest or 2 to perform an audible walktest. The display will read *UNIT IN WALKTEST*. To end the Walktest, press the Esc (Escape) key.

Pressing 3 after the walktest has been completed, will allow the operator to view the results of the walktest.

3.7.5 System

To program the time and date into the control panel, press 2 while viewing Maintenance Screen #2. The following display will appear:

```

SYSTEMS
1=TIME/DATE

```

System Screen

Pressing *1* while viewing the System Screen will cause the following screen to be displayed:

```
TIME AND DATE
1=TIME  01:00 AM
2=DATE  01-01-2001
                12HR
```

Time and Date Screen

To change the time, press *1* to display the following screen:

```
ENTER TIME
█
01:00 AM
1=AM                2=PM
```

Time Screen

A flashing cursor will appear on the left side of the display. Enter the four digit number corresponding to the time (0000 - 1259). When the fourth digit is entered, the cursor will move one position to the right. Press *1* for AM or *2* for PM to complete entering the time. The display will return to the Time and Date Screen displaying the new time.

To change the date, press *2* while viewing the Time and Date Screen. The following screen will be displayed:

```
ENTER DATE
█
MONTH DAY YEAR
01-01-2001
```

Date Screen

A flashing cursor will appear on the left side of the display. Enter the two digit month, two digit day and four digit year. The cursor will move one position to the right after each entry. When the fourth digit of the year has been entered, the display will return to the Time and Date Screen which will show the new date.

3.7.6 Zone Setup

```
PROGRAMMING
1=WALKTEST
2=SYSTEM
3=ZONE SETUP
```

Maintenance Screen #2

Pressing 3 while viewing Maintenance Screen #2 will display the following screen:

```
ZONE SETUP
1=ENABLE
2=DISABLE
3=ZONE 97 98 99
```

Zone Setup Screen

Pressing 1 while viewing Zone Setup screen will display the following screen:

```
ZONE TO ENABLE
Z █
```

Enable Screen

A flashing cursor appears to the right of the Z. To enable a zone, enter the two digit zone number (00 - 99). After the second digit is entered, the zone will be enabled and the cursor will return to the original position. The next zone to be enabled can then be entered. Press Esc (Escape) to return to the previous screen.

Pressing 2 while viewing Zone Setup screen will display the following screen:

```
ZONE TO DISABLE
Z █
```

Disable Screen

A flashing cursor appears to the right of the Z. To disable a zone, enter the two digit zone number (00 - 99). After the second digit is entered, the zone will be disabled and the cursor will return to the original position. The next zone to be disabled can then be entered. Press Esc (Escape) to return to the previous screen.

Pressing 3 while viewing Zone Setup screen will display the following screen:

SPEC PURPOSE ZONE		
1=PAS	97	OFF
2=PRE-SIGNAL	98	OFF
3=FUTURE	99	OFF

Disable Screen

Zones 97, 98 and 99 can be programmed for normal zone operation or for special purpose applications. In the above illustration, the three zones are shown Off, which means they can be programmed to function in the same manner as all other zones, by assigning them to input and output devices in the Programming Zone Assignment Screen.

Pressing 1 will cause the display to change to *PAS 97 On*. Each press of the 1 key will cause the display to toggle between *PAS 97 On* and *PAS 97 Off*. When Zone 97 is programmed On, a PAS (Positive Alarm Sequence) activation of any device will cause Zone 97 to activate. By assigning Zone 97 to a control module in the Programming Zone Assignment Screen, an output device connected to the control module can be used to indicate a PAS condition in the control panel. *Do not assign Zone 97 to a Notification Appliance Circuit when using this zone to indicate a PAS condition.*

Pressing 2 will cause the display to change to *Pre-signal 98 On*. Each press of the 2 key will cause the display to toggle between *Pre-signal 98 On* and *Pre-signal 98 Off*. When Zone 98 is programmed On, a Pre-signal activation of any device will cause Zone 98 to activate. By assigning Zone 98 to a control module in the Programming Zone Assignment Screen, an output device connected to the control module can be used to indicate a Pre-signal condition in the control panel. *Do not assign Zone 98 to a Notification Appliance Circuit when using this zone to indicate a Pre-signal condition.*

Zone 99, in special purpose mode, is reserved for future use and has no effect.

SECTION 4 Operating Instructions

4.1 Panel Control Buttons

4.1.1 Acknowledge/Step

The first press of the *Acknowledge/Step* key silences the piezo sounder, changes flashing LEDs to steady and also changes the status field on the LCD display from capital letters to small letters. When the piezo is silenced, an *acknowledge* message is sent to the printer and the history file. Multiple active events are scrolled on the display at a three second rate. *Acknowledge* also sends a *silence piezo* command to the optional annunciators connected to the FACP.

When more than one event exists, the first press of the Acknowledge/Step key functions as described in the preceding paragraph. The second press of the key stops the scrolling and holds the event on the display for one minute. Subsequent pressing of the key *steps* through each active event.

4.1.2 Alarm Silence

The *Alarm Silence* key performs the same functions as Acknowledge/Step. In addition, if an alarm exists, it turns off all silenceable NACs (Notification Appliance Circuits) and causes the Alarm Silenced LED to turn on. It also sends an 'alarm silenced' message to the printer, history file and optional annunciators. A subsequent new alarm will resound the system NACs. *Note that the Alarm Silenced LED is turned off by pressing the Reset key, the Drill key or subsequent activation of the NACs.*

4.1.3 Drill/Hold 2 Sec

When the *Drill* key is held for a minimum of two seconds (time required to prevent accidental activations), the FACP turns on both main panel NAC outputs and all silenceable circuits such as control modules that are programmed as silenceable, and turns off the Alarm Silenced LED if it was previously on. The *EVAC IN SYSTEM* message is shown on the LCD display. The same message is sent to the printer and history file. The *Alarm Silence* key can be used to turn off all silenceable NAC outputs following activation by the *Drill* key.

4.1.4 Reset

Pressing and releasing the *Reset* key turns off all control modules and NACs, temporarily turns off resettable power to 4-wire detectors, causes a *RESET IN SYSTEM* message to be displayed on the LCD and sends the same message to the printer and history file. It also performs a lamp test by turning on all LEDs (except the Ground LED), piezo sounder and LCD display segments after the *Reset* key is released. Any alarm or trouble that exists after a reset will resound the system.

4.2 LED Indicators

The nine LED indicators, which are located on the front panel, operate as follows:

AC Power

This is a green LED which illuminates if AC power is applied to the FACP. A loss of AC power will turn off this LED

Fire Alarm

This red LED flashes when one or more alarms occur. It illuminates steady when the *Acknowledge/Step* or *Alarm Silence* key is pressed. The Fire Alarm LED turns off when the *Reset* key is pressed. The LED will remain off if all alarms have been cleared.

Supervisory

This is a yellow LED that flashes when one or more supervisory conditions occur, such as a sprinkler valve tamper condition. It illuminates steady when the *Acknowledge/Step* or *Alarm Silence* key is pressed. It turns off when the *Reset* key is pressed and remains off if all supervisory alarms have been cleared.

Trouble

This is a yellow LED that flashes when one or more trouble conditions occur. It stays on steady when the *Acknowledge/Step* or *Alarm Silence* key is pressed. The LED turns off when all trouble conditions are cleared. This LED will also illuminate if the microprocessor watchdog circuit is activated.

Maintenance

This is a yellow LED that flashes to indicate that a smoke detector requires cleaning or replacement due to an invalid chamber reading or excessive drift.

Alarm Silenced

This is a yellow LED that turns on after the *Alarm Silence* key is pressed while an alarm condition exists. It turns off when the *Drill* or *Reset* key is pressed.

Disabled

This is a yellow LED that flashes to indicate that a zone, NAC, detector or module has been temporarily disabled in programming by the user.

Battery

This is a yellow LED that flashes to indicate a low battery voltage condition.

Ground

This is a yellow LED that flashes to indicate a ground fault condition.

Primary Line Active

This is a red LED that indicates the primary phone line is active.

Secondary Line Active

This is a red LED that indicates the secondary phone line is active

Kiss-off

This is a green LED that blinks when a Central Station has acknowledged receipt of each transmitted message or when a portion of upload or download data has been accepted from a Service Terminal

4.3 Normal Operation

With no alarms or troubles in the system, the display message is *System All Normal* along with the current time and date as shown below. To set the time and date, refer to the appropriate section in this manual.



```
FIRE-LITE ALARMS INC
SYSTEM ALL NORMAL
10:00A 012102
```

The MS-9200UD performs the following functions at regular intervals while in Normal mode:

- ✓ Monitors AC input voltage and battery voltage
- ✓ Monitors and reports status of SLC loop, option cards and control panel
- ✓ Polls all devices on the SLC loop and flashes each device LED while checking for valid replies, alarms, troubles, etc.
- ✓ Refreshes LCD display and updates time
- ✓ Scans control panel keypad for key presses
- ✓ Performs autotest for all SLC devices
- ✓ Tests memory
- ✓ Updates and reads all communications busses (EIA-485, EIA-232, etc.)

4.4 Trouble Operation

With no alarms in the system, the detection of a trouble will cause the following:

- The piezo to pulse 1 second On and 1 second Off
- The system Trouble LED to flash one second On and one second Off
- The trouble relay to activate
- *TROUBL* with device type, noun/adjective, address and trouble description will appear on the LCD display
- The same message, along with the time and date, is sent to the optional printer and the history buffer.
- Communicate the trouble conditions to the Central Station
- Terminate upload or download communications

Note that specific troubles will initiate additional actions; for example, loss of AC power will turn off the AC Power LED, a ground fault will turn on the Ground LED, etc.

Addressable Smoke Detectors, Monitor Modules and Control Modules

For addressable devices connected to the SLC loop, the following is a typical message that could appear on the LCD display for a device trouble:

```

TROUBL SMOKE (PHOTO)
  <ADJ> <NOUN>
          INVREP
10:00A 010801 10001
  
```

The information displayed in the above example provides the following information:

- First line in display:
 - ✓ The type of event; in this example *TROUBL* indicating a device trouble
 - ✓ Device type identifier; in this example, *SMOKE (PHOTO)* indicates a Photoelectric smoke detector. Other device type identifiers which can be displayed include *SMOKE (ION)* for Ionization Detector, *HEAT* for Heat Detector, *CONTROL* for Control Module and *MONITOR* for Monitor Module, *PULL STATION* for a manual pull box, etc. Refer to "Edit Detector" on page 51, "Edit Module Screen for Monitor Module" on page 61 and "Edit Module Screen for Control Modules" on page 70 for information on additional device types.
- Second line in display:
 - ✓ <ADJ>; refers to the user programmed adjective descriptor from library list resident in the control panel or custom entry via PC.
 - ✓ <NOUN>; refers to the user programmed noun descriptor from library list resident in the control panel or custom entry via PC.
- Third line in display: *INVREP* indicates an invalid reply from the addressable device. Other possible troubles include:
 - SHORT* - indicating a shorted circuit on an addressable device
 - OPEN* - indicating an open circuit on an addressable device
 - DIRTY1* - maintenance alert indicating that a detector is near but below the allowed alarm limit and is in need of maintenance before the performance is compromised
 - DIRTY2* - maintenance alert indicating that a detector needs immediate maintenance since it has been within 80% of its alarm threshold for 24 hours
 - INVREP* - maintenance alert indicating a hardware problem in the detector
 - TEST F* - indicating a detector has failed the automatic test operation which functionally checks its sensing chamber and electronics
 - INV ID* - indicating that an incorrect device code (Type ID) has been programmed for an installed device (for example, Photo has been programmed but an Ion detector has been installed)
 - SW TBL* - indicating a module has failed the testing of its Class A switching relay
- Fourth line in display:
 - ✓ Time; the current time in this example is *10:00A* which represents 10:00 AM
 - ✓ Date; the current month, day and year in this example is *01* for January, *08* for the 8th day of the month and *01* for the year 2001
 - ✓ Device Address; *1D001* in this example *1* represents SLC Loop, *D* represents a detector and *001* represents device address 001

Pressing the *Acknowledge/Step* or *Alarm Silence* key will cause the pulsing piezo to silence and the system Trouble LED to change from flashing to on steady. This block acknowledgment occurs regardless of the number of troubles, alarms and supervisory events active in the system. When the *Acknowledge/Step* key is pressed and at least one new alarm or trouble exists in the system, the 'acknowledge' message is sent to the printer and history file. If the trouble clears, either before or after the *Acknowledge/Step* key is pressed, the 'clear trouble' message is sent to the printer and history file.

If all troubles clear and there are no supervisory or fire conditions active in the system, the system returns to normal mode operation and the *System All Normal* message is shown on the LCD display and sent to the history and printer files. The auto-restore feature will restore cleared troubles even if the troubles were never acknowledged. Note that pressing the *Alarm Silence* key when only troubles exist in the system will have the same effect as pressing the *Acknowledge/Step* key except the Alarm Silenced LED will light.

If multiple trouble conditions exist in the system, they will be automatically scrolled on the LCD display at a three second rate. *If a combination of alarms, troubles and/or supervisory conditions simultaneously occur in the system, only the alarms are scrolled on the display.*

4.5 Alarm Operation

Alarm operation is similar to trouble operation with the following differences:

- The piezo sounder produces a steady output as opposed to a pulsed output
- The Fire Alarm LED flashes 1 second On and 1 second Off
- The LCD displays *Alarm* along with the device name, type, address, adjective/noun, associated zones and time/date
- Communicate the alarm to the Central Station
- Alarms latch and *are not allowed to clear automatically*
- Alarms activate software zones if so programmed
- Timers for Silence Inhibit, Autosilence and Trouble Reminder are started
- Alarms activate the general alarm relay and general alarm zone Z00
- The trouble relay is not activated
- Store event in history buffer
- Terminate upload or download communications

A typical alarm display would be as illustrated below:

```

ALARM  PULL STATION
      <ADJ> <NOUN>
                Z000
10:00A 010801 1M001
  
```

Note that the device type, which in this example is *PULL STATION*, can be any other programmable alarm type.

The information displayed in the above example provides the following information:

- First line in display:
 - ✓ The type of event; in this example *ALARM* indicating an alarm condition
 - ✓ Device type identifier; in this example, *PULL STATION* indicates a manual pull box. Other device type identifiers which can be displayed include *SMOKE (ION)* for Ionization Detector, *HEAT* for Heat Detector, *CONTROL* for Control Module and *MONITOR* for Monitor Module, *PULL STATION* for a manual pull box, etc. Refer to "Edit Detector" on page 51, "Edit Module Screen for Monitor Module" on page 61 and "Edit Module Screen for Control Modules" on page 70 for information on additional device types.

- Second line in display:
 - ✓ <ADJ>; refers to the user programmed adjective descriptor from library list resident in the control panel or custom entry via PC.
 - ✓ <NOUN>; refers to the user programmed noun descriptor from library list resident in the control panel or custom entry via PC.
- Third line in display: *Z000* indicates the zone programmed to this device which, in this example, is general alarm Zone 000. Note that a single device can be programmed to five different zones but only the first zone will be displayed.
- Fourth line in display:
 - ✓ Time; the current time in this example is *10:00A* which represents 10:00 AM
 - ✓ Date; the current month, day and year in this example is *01* for January, *08* for the 8th day of the month and *01* for the year 2001
 - ✓ Device Address; *1M001* in this example *1* represents SLC Loop, *M* represents a module and *001* represents device address 001

4.6 Supervisory Operation

Supervisory operation is similar to alarm operation but with the following differences:

- The piezo sounder pulses ½ second On and ½ second Off
- The Supervisory LED flashes ½ second On and ½ second Off
- The LCD displays the status label *Active Supervisory* along with the device name, type, address, adjective/noun, associated zones and time/date
- Communicate the supervisory condition to the Central Station
- The supervisory relay is activated
- The alarm relay is not activated
- Silenced alarms are resounded
- Timers are not started
- Store event in history buffer
- Terminate upload or download communications

A typical Supervisory event would be displayed as illustrated in the following:

```

ACTIVE SUPERVISORY
  <ADJ> <NOUN>
                Z000
10:00A 010801 1M001
```

Note that, like alarms, supervisory signals latch (except when programmed for supervisory autoresettable) and can be assigned to software zones. Supervisory alarms do not cause resound as do other alarm conditions. Open circuits in supervisory wiring are processed by the control panel the same way as other trouble conditions. Refer to "Alarm Operation" on page 134, for a description of the information displayed on the control panel LCD.

4.7 Process Monitor Operation

Process Monitor operation will initiate the following events:

- The piezo sounder pulses $\frac{1}{4}$ second On and $\frac{1}{4}$ second Off
- The LCD displays a process monitor message along with the device name, type, address, adjective/noun, associated zones and time/date
- Communicate the process monitor condition to the Central Station
- Relays programmed for process monitoring will be activated
- The alarm relay is not activated
- Silenced alarms are not resounded
- Timers are not started
- Store event in history buffer

Note that, like supervisories, process monitor signals latch (except when programmed for process monitor autoresettable) and can be assigned to software zones.

4.8 Hazard/Tornado Condition Operation

Hazard/Tornado Condition operation will initiate the following events:

- The piezo sounder pulses $\frac{1}{2}$ second On, $\frac{1}{2}$ second Off
- The LCD displays a hazard message along with the device name, type, address, adjective/noun, associated zones and time/date
- Communicate the hazard condition to the Central Station
- Relays programmed for hazard will be activated
- The alarm relay is not activated
- Silenced alarms are resounded
- Timers are not started
- Store event in history buffer
- Supervisory LED flashes $\frac{1}{2}$ second On, $\frac{1}{2}$ second Off

Hazard conditions latch. They can be assigned to software zones.

4.9 Medical Alert Condition Operation

Medical Alert Condition operation will initiate the following events:

- The piezo sounder $\frac{1}{2}$ second On, $\frac{1}{2}$ second Off
- The LCD displays a medical alert message along with the device name, type, address, adjective/noun, associated zones and time/date
- Communicate the medical alert condition to the Central Station
- Relays programmed for medical alert will be activated
- The alarm relay is not activated
- Silenced alarms are resounded
- Timers are not started
- Store event in history buffer
- Supervisory LED flashes $\frac{1}{2}$ second On, $\frac{1}{2}$ second Off

Medical alert conditions latch. They can be assigned to software zones.

4.10 NAC Operation

There are four Style Y (Class B) or two Style Z (Class A) programmable NACs (Notification Appliance Circuits) resident on the MS-9200UD main circuit board. All NACs may be programmed as silenceable or nonsilenceable and may also be programmed for steady or coded operation. Coded operation provides a choice between March Time, Temporal or California coding.

4.11 Programmed Zone Operation

Each addressable detector and monitor module can be assigned to a maximum of five software alarm zones. A general alarm zone Z00 may be listed for output (control) points, but it is not necessary to list Z00 for input points, since this is the default zone for all alarm input devices. Zone Z00 is not activated by supervisory points.

When an input device alarms and is not disabled, it activates all software zones assigned to it. An output device that is not disabled is turned on when any of the software zones to which it is programmed become active. Only alarms, hazards/tornado alerts can turn on any of the four main NACs.

4.12 Disable/Enable Operation

Input points which are disabled do not cause an alarm or any zone activation. Disabled output points are held in the off state. All disabled points are treated as if they were in trouble, with the exception being the status label that will be displayed is *DISABL*.

4.13 Waterflow Circuits Operation

If an alarm exists from a monitor module point that has a waterflow type code and its mapped NAC control module outputs are programmed for nonsilenceable operation, the Alarm Silence key will not function. Also, any output zone activated by a waterflow device will not be silenceable if the Waterflow Silenceable option is set to NO in system programming.

4.14 Detector Functions

Maintenance Alert

Each addressable detector is monitored by the control panel for its maintenance status. If a detector is near but below the allowed alarm limit, a 'maintenance alert' message will automatically be displayed, signaling that the detector is in need of servicing.

Automatic Test Operation

An automatic test of an addressable detector is performed each minute, resulting in a complete SLC loop test in approximately 5 hours (if the loop has the maximum number of devices installed). The detector's sensing chamber and electronics are functionally tested for normal, safe operation. A trouble message is displayed upon failure of this test. A System Reset will clear this trouble.

Type Code Supervision

The FACP monitors addressable hardware device codes at slow intervals. Mismatch of any type code, compared to the system program, will cause a device trouble.

System Alarm Verification

The control panel may be programmed to perform alarm verification to help eliminate the nuisance of false alarms. Alarm verification applies to smoke detectors only.

Smoke Detector Data

Smoke detector data is monitored by the FACP, eliminating the need to test the sensitivity of each detector at its location. A printout of each detector's data can be retrieved from the FACP using an optional printer or Windows® HyperTerminal. Detector sensing ability can decrease with age and should be monitored as part of a system's routine maintenance.

4.15 Time Functions: Real-Time Clock

The MS-9200UD includes a crystal-based clock that provides time of day, date and day of week. Time is displayed as 12 or 24 hour time with month/day/year and is stored in RAM. Daylight savings time change-over is programmable and automatic. If both AC and battery are lost, the time must be reset.

4.16 Synchronized NAC Operation

Synchronization is a panel feature that controls the activation of notification appliances in such a way that all devices will turn on and off at exactly the same time. This is particularly critical when activating strobes which must be synchronized to avoid random activation and a potential hazard or confusion. The FACP can be programmed to operate with a variety of manufacturer's devices. NAC synchronization can only be supported properly by the Remote Power Supply Sync Terminal, which follows NAC 1 programming.

Important: *When a Notification Appliance Circuit with a mix of audible and visual devices is programmed for silenceable and the synchronization feature is selected, only the audible devices will be turned off if the Silence key is pressed. The visual devices (strobes, etc.) will continue to operate.*

4.17 Coded Operation

The NAC circuits resident on the control panel main circuit board can be programmed for coded operation. The available pulse rates which can be programmed for coded operation are as follows:

- Continuous: Steady output with no pulsing
- March Time: Pulses at 120 ppm (pulses per minute)
- Temporal Code: Pulses at ½ second On, ½ second Off, ½ second On, ½ second Off, ½ second On, 1½ second Off
- California Code: 10 seconds On, 5 seconds Off
- Two-Stage: Pulses at 20 ppm (pulses per minute) for 5 minutes and then changes to on steady

4.18 Presignal



Presignal option programs an initiating device to delay the activation of NACs and/or control modules while allowing visual verification by a person. Once a detector or monitor module triggers an alarm, the onboard piezo sounds immediately, but the NACs are not activated for a user programmed time duration of up to three minutes. Note that the alarm relay and communicator will respond to the initial alarm immediately. In addition, Zone 98 will activate. This zone can be programmed to a control module which may be used to activate a sounder or indicator which the installer designates as a Presignal indication. *Do not assign Zone 98 to a Notification Appliance Circuit when using this zone to indicate a Pre-signal condition.*

After the programmed delay, the NACs will activate if the source of the alarm is not cleared. Note that if a second alarm occurs during the programmed time delay, the alarm will be processed immediately, causing activation of the appropriate output zones. The events which occur upon Presignal activation are as follows:

- ✓ onboard piezo sounds immediately
- ✓ control panel LCD display will indicate a presignal event and the active point
- ✓ control points programmed to Zone 98 will activate
- ✓ annunciators (if enabled) will sound the local piezo, and pulse the alarm LED and zone LED
- ✓ outputs (NACs and control modules) of associated zones will be inhibited from activating for a user programmed time delay of up to three minutes
- ✓ second alarm occurring anytime during the time delay will cause immediate activation of all associated outputs

Presignal does not affect monitor modules programmed as waterflow, supervisory, process monitoring or remote switches. *Presignal operation requires the approval of the local Authority Having Jurisdiction.*

4.19 Positive Alarm Sequence

PAS (Positive Alarm Sequence) option will program an initiating device to delay panel activation (including alarm relay and communicator) for a period of 15 seconds. Zone 97, however, will activate immediately and may be used to connect a signaling device to indicate PAS activation. *Do not assign Zone 97 to a Notification Appliance Circuit when using this zone to indicate a PAS condition.*

When a detector or monitor module triggers an alarm, the onboard piezo sounds immediately, but the NACs are prevented from activating for 15 seconds. This inhibit time is factory set and cannot be changed. Pressing the Alarm Silence or Acknowledge/Step key during the 15 second inhibit time will silence the piezo sounder and start a timer which prevents activation of NACs for an additional time duration which can be user programmed for up to three minutes. After the programmed delay, the NACs will activate if the source of the alarm is not cleared. Note that if a second alarm occurs during either time delay, the alarm will be processed immediately, causing activation of the appropriate output zones. The events which occur upon PAS activation are as follows:

- ✓ onboard piezo sounds immediately
- ✓ control panel LCD display will indicate a presignal event and the active point
- ✓ control points programmed to Zone 97 will activate
- ✓ annunciators (if enabled) will sound the local piezo, and pulse the alarm LED and zone LED
- ✓ outputs (NACs and control modules) of associated zones will be inhibited from activating for a factory set duration of 15 seconds
- ✓ pressing the Alarm Silence or Acknowledge/Step key will start a timer which inhibits output activation for additional time delay of up to three minutes which is user programmable
- ✓ second alarm occurring anytime during either time delay will cause immediate activation of all associated outputs

PAS does not affect monitor modules programmed as waterflow, supervisory, process monitoring or remote switches. *PAS operation requires the approval of the local Authority Having Jurisdiction.*

Note that the *PAS BYPASS* monitor type code, when activated, will inhibit the PAS capability until the *PAS BYPASS* monitor is deactivated. While PAS is inhibited, signaling devices will immediately place the control panel into alarm. This feature may be employed by wiring a normally open device, such as a switch, to a monitor module which has been programmed for *PAS BYPASS*.

4.20 Special System Timers

4.20.1 Silence Inhibit Timer

This option, if selected, prevents the *Alarm Silence* key from functioning for 60 seconds following an alarm. A new alarm during the initial 60 second period will not cause the timer to restart with a new 60 seconds. *Silence Inhibit operation requires the approval of the local Authority Having Jurisdiction.*

4.20.2 Autosilence Timer

If Autosilence is selected, the notification appliances, programmed as silenceable, will automatically be silenced after a programmable duration of from 5 to 30 minutes. Pressing the *Drill* key will restart the timer. *Autosilence operation requires the approval of the local Authority Having Jurisdiction.*

4.20.3 Trouble Reminder

If selected, this feature causes a reminding 'beep' every 15 seconds during an alarm (after the *Alarm Silence* key is pressed) and every two minutes during a trouble condition (after the *Acknowledge/Step* or *Alarm Silence* key is pressed). The 'beeps' from the onboard piezo sounder will occur until the alarm or fault is cleared.

Note that if the trouble is not cleared within 24 hours, the piezo will resound, indicating that the trouble condition still exists.

4.20.4 Waterflow Retard Timer

If selected, this option will delay the activation of a waterflow type alarm for a programmable time duration from 1 to 90 seconds. This delay is in addition to any time delay inherent in the waterflow device. *This feature requires the approval of the local Authority Having Jurisdiction.*

4.20.5 Alarm Verification (None or One Minute)

If alarm verification is selected, an addressable smoke detector's alarm is ignored for a retard time of 13 seconds and the detector's alarm condition is automatically reset. There will be no alarm indication at the FACP during the Retard period. A confirmation period of 47 seconds follows, during which a subsequent alarm from the same detector will cause the panel to immediately activate the appropriate outputs and indicate the alarm condition at the FACP. If a different detector alarms any time during the first detector's verification period, the panel will immediately activate all appropriate outputs and indicate the alarm condition at the FACP. If no additional detector alarms occur within 60 seconds of the first alarm (13 second retard plus 47 second confirmation), the timer resets and the panel is ready to verify any new detector alarms which may occur.

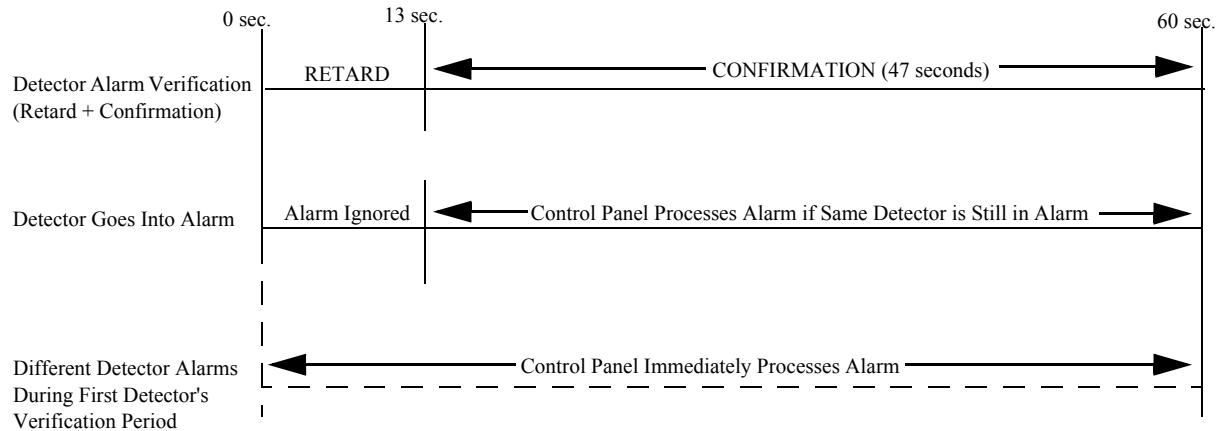

Note: Alarm Verification is available only for addressable smoke detectors, not conventional smoke detectors.

4.21 Walktest

Walktest is a feature which allows one person to test the fire alarm system. An audible walktest will momentarily sound the Notification Appliance Circuits in the building and store the walktest information in a file at the panel. A silent walktest will not sound the NACs but will store the walktest information in a file which can be viewed at the panel. Disabled NAC devices will not activate during walktest.

Alarm/Shorted Condition

When in audible Walktest, the panel responds to each new alarm and activates its programmed control outputs for four seconds, if those outputs have been programmed for silenceable activation. It also stores each alarm in the walktest history file which can be sent to an optional printer. The stored display will be the same as if the device actually activated except the colon (:) in the time stamp is replaced with an asterisk (*).

Open Condition

Addressable devices as well as all main circuit board NACs are monitored for fault conditions during Walktest mode. When a new trouble condition occurs, the FACP will activate all NACs and control modules programmed for Walktest, then shut them off after eight seconds.

While in Walktest, the trouble relay is activated and the system Trouble LED flashes (as in all of the Program and status change operations). The alarm relay is not activated.

4.22 Read Status

Read Status functions do not require a password. The control panel will continue to provide fire protection while in Read Status mode. This mode can be entered while the control panel is in alarm or trouble. If a new alarm or trouble occurs during these functions, the Read Status is exited to prevent confusion.

Read Status Entry

When the operator presses the control panel *Enter* key, the LCD will display the following:



Pressing *1*, while this screen is being displayed, will cause the control panel to enter the Read Status mode which allows the user to view and print the programmed features and status of the control panel.

The following screens will be displayed:

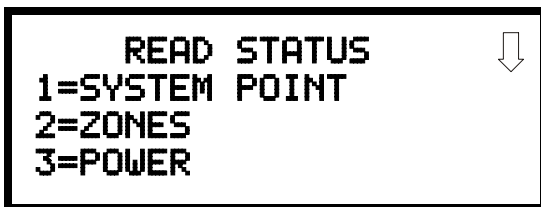

Read Status Screen #1

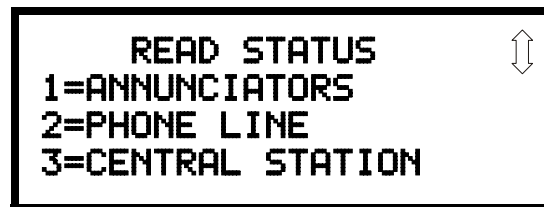

Read Status Screen #4

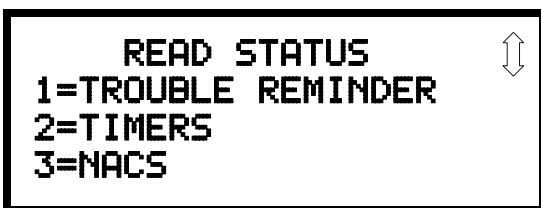

Read Status Screen #2

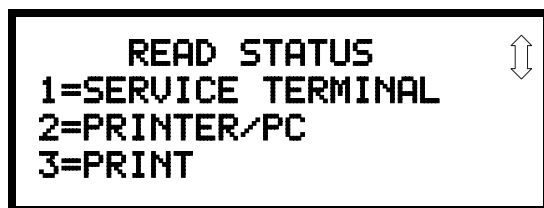

Read Status Screen #5

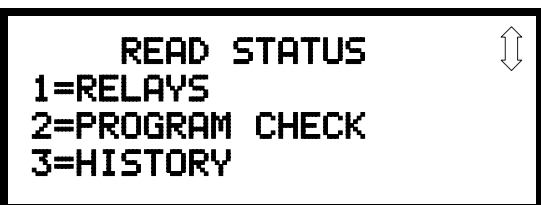

Read Status Screen #3



Read Status Screen #6

4.22.1 System Point

```

READ STATUS
1=SYSTEM POINT
2=ZONES
3=POWER

```

Read Status Screen #1

Pressing *1* while viewing Read Status Screen #1 will cause the following screen to be displayed:

```

READ SYSTEM POINT
SELECT TYPE
1=DETECTOR
2=MODULE

```

The operator selects the type of device which is to be viewed by pressing *1* for Detector or *2* for Module. If *1* is pressed, the display will change to the following screen:

```

READ SYSTEM POINT
ENTER DETECTOR#
***

```

Entering the three digit detector address will cause the control panel to display the current status of the selected device. For example, if a detector with address *001* on the SLC loop is entered, a display similar to the following will appear:

```

NORMAL SMOKE<PHOTO>
NORTH CLASSROOM
                Z005
                V  1D001

```

The information in the preceding display includes:

- *NORMAL* - the present status (could also be ALARM, TROUBL, DISABL, etc.)
- *SMOKE (PHOTO)* - the device type which is a photoelectric smoke detector (could also be ION for ionization smoke detector)
- *NORTH CLASSROOM* - the Adjective/Noun label for this device
- *Z005* - the first of five possible assigned software zones
- *1D001* - *1* = SLC Loop, *D* = Detector, *001* = Address 001
- *V* - Alarm Verification Enabled (V = Yes, * = No)
- *S* - Silenceable for control modules (S = Yes, * = No)
- *W* - Walktestable for control and monitor modules (W = Yes, * = No)

Pressing the down arrow key, while viewing the screen shown above, will allow the operator to view additional programming information about the selected device, such as:

- Enable/Disable Status
- Device Type
- Alarm Verification On/Off (for detectors)
- Walktest Yes/No
- PAS (Positive Alarm Sequence) Yes/No (for detectors and monitor modules)
- Pre-Signal Yes/No (for detectors and monitor modules)
- Zone Assignments (five maximum)
- Adjective/Noun descriptor
- Silenceable Yes/No (for control modules)

4.22.2 Zones

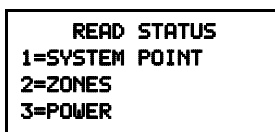

Read Status Screen #1

Pressing 2 while viewing Read Status Screen #1 will cause the following screens to be displayed:



Zones Screen #1

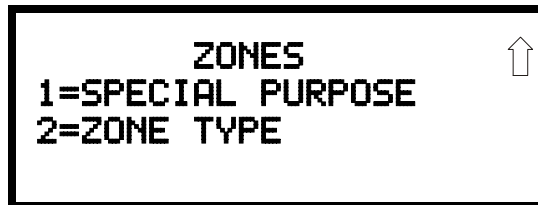

Zones Screen #2

From the preceding screens, the control panel operator can view:

- *Zones Installed* - all software zones programmed into the system (99 maximum)
- *Zones Enabled* - all software zones that are enabled
- *Zones Disabled* - all software zones that have been disabled
- *Special Purpose* - on or off programming for Special Purpose Zones 97 reserved for PAS, 98 reserved for Pre-signal and 99 reserved for future use
- *Zone Type* - the Type assigned to each installed zone (default is Alarm)

4.22.3 Power

Pressing 3 while viewing Read Status Screen #1 will cause the following screens to be displayed:

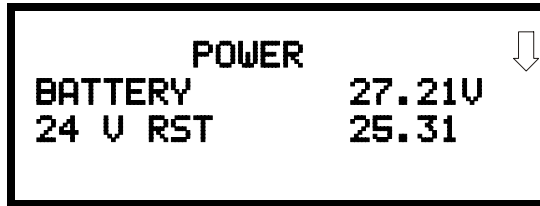

Power Screen #1

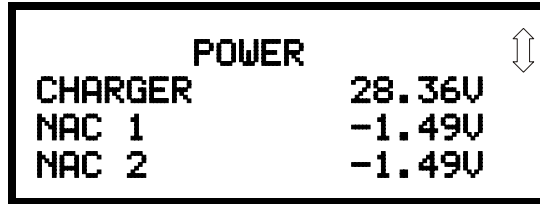

Power Screen #2

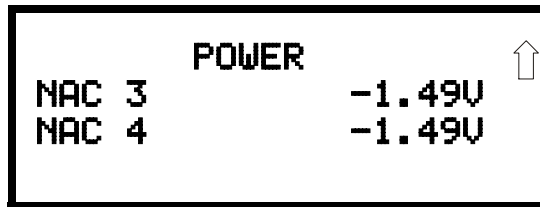

Power Screen #3

A real-time display of the control panel voltages can be used to determine if a problem exists in the system. *Note that **Power Screen #3** will only be displayed if the NACKEY NAC option card is installed, in JP8 of the main circuit board, for Class B operation.*

The following table lists the circuit being measured, possible conditions and their respective voltage ranges:

Circuit	Condition	Voltage Range
Battery	Normal Battery (nominal)	27.05 to 28.15 VDC
	Low Battery	20.0 to 20.8 VDC
	No Battery	0 to 18.36 VDC
24V Resettable	Normal	21.25 to 27.50 VDC
24V Nonresettable	Normal	21.25 to 27.50 VDC
Charger	Normal	21.87 to 29.84 VDC
NAC 1 or NAC 2	Normal	-1.3 to -1.6 VDC
	Open Circuit	-2.3 to -2.5 VDC
	Short Circuit	0 to 1.0 VDC

4.22.4 Trouble Reminder

```

READ STATUS
1=TROUBLE REMINDER
2=TIMERS
3=NAC
    
```

Read Status Screen #2

Pressing 1 while viewing Read Status Screen #2 will display the following screen:

```

TROUBLE REMINDER
TROUBLE REM      ON
    
```

The screen indicates whether the Trouble Reminder feature is On or Off.

4.22.5 Timers

Pressing 2 while viewing Read Status Screen #2 will cause the following Timer screens to be displayed:

```

          TIMERS
PAS DELAY      000
PRE SIGNAL     000
WATERFLOW     000
    
```

```

          TIMERS
AC LOSS DELAY  4
    
```

These screens will indicate the delay time, in seconds, for each of the first three possible delay options. The AC Loss Delay time is displayed in hours.

4.22.6 NAC

Pressing 3 while viewing Read Status Screen #2 will display the following screen:

```

                NAC
1=NAC 1      3=NAC 3
2=NAC 2      4=NAC 4
  
```

Note that 3=NAC 3 and 4=NAC 4 will always be displayed regardless of how the NACKEY NAC option card is installed.

The operator can press 1 to view the programmed options for NAC 1, 2 to view the programmed options for NAC 2, 3 to view the programmed options for NAC 3 or 4 to view the programmed options for NAC 4. The resulting screens will display the following information:

- Enable/Disable Status
- Circuit Type (Bell, Strobe, etc.)
- Silenceable/Nonsilenceable
- Auto Silence Enable/Disable and time delay (in minutes)
- Coding Selection (Temporal, Steady, etc.)
- Zone Assignments
- Silence Inhibit Enabled/Disabled
- Synchronization Type (System Sensor, Wheelock or Gentex)

4.22.7 Relays

```

  READ STATUS
1=RELAYS
2=PROGRAM CHECK
3=HISTORY
  
```

Read Status Screen #3

Pressing 1 while viewing Read Status Screen #3 will display the following screen:

```

                RELAY
1=RELAY 1
2=RELAY 2
3=RELAY 3
  
```

The operator can view the programmed option for each relay by pressing the corresponding number key.

4.22.8 Program Check

Pressing 2 while viewing Read Status Screen #3 will cause a screen similar to the following to be displayed:

```
PROGRAM CHECK
1=NACS NO INPUT
2=ZONES NO INPUT
3=ZONES NO OUTPUT
```

Pressing 1 while viewing the Program Check screen will display a screen which will indicate if any input zones have not been programmed to one of the Notification Appliance Circuits. Use the up and down arrow keys to view all NACs.

Pressing 2 while viewing the Program Check screen will display a screen which will indicate if any output zones have not been programmed to at least one input zone. Use the up and down arrow keys to view all zones.

Pressing 3 while viewing the Program Check screen will display a screen which will indicate if any input zones have not been programmed to at least one output zone. Use the up and down arrow keys to view all zones.

4.22.9 History

Pressing 3 while viewing Read Status Screen #3 will display the following screen:

```
HISTORY
1=VIEW ALL
2=VIEW ALARMS
3=VIEW OTHER EVENTS
```

The operator can view all events which have been stored in the history file, only alarms or other events, such as troubles or supervisories, by pressing the corresponding number key.

4.22.10 Annunciators

```

READ STATUS
1=ANNUNCIATORS
2=PHONE LINE
3=CENTRAL STATION
    
```

Read Status Screen #4

Pressing 1 while viewing Read Status Screen #4 will display the following screens:

```

ANNUNCIATORS
TERM ENABLED    YES
ACS ENABLED     YES
UDACT ENABLED   NO
    
```

Annunciator Screen #1

```

ANNUNCIATORS
1=ACS ADDRESS
    
```

Annunciator Screen #2

Annunciator Screen #1 indicates if Terminal Mode, ACS Mode and UDACT options are enabled or disabled. Pressing '1' while viewing Annunciator Screen #2 allows the operator to view the ACS Mode Annunciator addresses which have been programmed into the control panel.

4.22.11 Phone Line

Pressing 2 while viewing Read Status Screen #4 will display the following screen:

```

PHONE LINE
PRIMARY    TOUCHTONE
SECONDARY  TOUCHTONE
    
```

This screen indicates the both the Primary and Secondary phone lines have been configured for touchtone dialing operation.

4.22.12 Central Station

READ STATUS
1=ANNUNCIATORS
2=PHONE LINE
3=CENTRAL STATION

Read Status Screen #4

Pressing 3 while viewing Read Status Screen #4 will display the following screens:

```

CENTRAL STATION
REPORTING      ENABLED
REPORT        BOTH
CALL LIMIT    10
  
```

Central Station Screen #1

```

CENTRAL STATION
1=PRIMARY
2=SECONDARY
3=REPORT STYLE
  
```

Central Station Screen #2

Central Station Screen #1 indicates whether the Central Station Reporting is enabled or disabled, if the Reports will be sent to one or both the Primary and Secondary Central Station phone numbers and the Call Limit for DACT trouble calls within a 24 hour period. Central Station Screen #2 provides information on the Primary and Secondary Central Station programming which includes:

- Test Time Interval
- Account Code
- 24 Hour Test Time
- Phone Number
- Communication Format
- Event Codes

4.22.13 Service Terminal

```

READ STATUS
1=SERVICE TERMINAL
2=PRINTER/PC
3=PRINT

```

Read Status Screen #5

Pressing 1 while viewing Read Status Screen #5 will display the following screens:

```

SERVICE TERMINAL
PANEL ID
2=TERMINAL 1
3=TERMINAL 2

```

Service Terminal Screen #1

```

SERVICE TERMINAL
RING COUNT

```

Service Terminal Screen #2

The Panel ID number is displayed as the first item in Service Terminal Screen #1.

To view the phone number for each Service Terminal, press 2 for Terminal 1 or 3 for Terminal 2 while viewing Service Terminal Screen #1.

The Ring Count is displayed in Service Terminal Screen #2.

4.22.14 Printer/PC

Pressing 2 while viewing Read Status Screen #5 will display the following screens:

```

PRINTER PC
PRINTER PC PR4800
START BIT
STOP BIT

```

Printer/PC Screen #1

```

PRINTER PC
DATA BITS
PARITY

```

Printer/PC Screen #2

The display will inform the operator as to whether the control panel is configured for a printer or a PC. In the example above, PR4800 indicates that the panel is configured for a printer with a baud rate of 4,800.

4.22.15 Print

```

READ STATUS
1=SERVICE TERMINAL
2=PRINTER/PC
3=PRINT
    
```

Read Status Screen #5

To print program data or control panel status, press 3 while viewing Read Status Screen #5. The following screens will be displayed:

```

PRINT
1=HISTORY
2=WALKTEST LOG
3=DETECTOR DATA
    
```

Print Screen #1

```

PRINT
1=EXIT PRINTING
    
```

Print Screen #2

Pressing 1 while viewing Print Screen #1 allows the user to print the History file which will detail all of the system activities since the file was last cleared from memory.

Pressing 2 while viewing Print Screen #1 allows the user to print the Walktest log which will detail all of the system activations during walktest since the log was last cleared. Refer to "Walktest" on page 97 for additional information on the display.

Pressing 3 while viewing Print Screen #1 allows the user to print the detector data for each addressable smoke detector connected to the system. A printout, similar to the following example, will be generated if an optional printer is connected to the FACP.

DEVICE#	DEVICE TYPE	%DRIFT COMP	CHAMBER	TIME/DATE
1D001	SMOKE (PHOTO)	20	1281	12:01AM 01-08-2001
1D002	SMOKE (PHOTO)	20	1281	12:01AM 01-08-2001
1D003	SMOKE (PHOTO)	21	1259	12:01AM 01-08-2001
1D004	SMOKE (PHOTO)	20	1309	12:02AM 01-08-2001
1D005	SMOKE (PHOTO)	21	1281	12:02AM 01-08-2001
1D006	SMOKE (PHOTO)	20	1322	12:02AM 01-08-2001
1D007	SMOKE (PHOTO)	20	1280	12:02AM 01-08-2001
1D008	SMOKE (PHOTO)	20	1215	12:02AM 01-08-2001
1D009	SMOKE (PHOTO)	20	1310	12:02AM 01-08-2001

Chamber Value

The Chamber value should be within the indicated range for the following smoke detectors:

- SD350(T), D350P(R) and SD300(T) Addressable Photoelectric Smoke Detectors: **405 - 2100** (obscuration of 1.00%/ft to 3.66%/ft.)
- CP350 and CP300 Addressable Ionization Smoke Detectors: **750 - 2100** (obscuration of 0.50%/ft. to 1.44%/ft.)

If the addressable smoke detector's Chamber reading is not within the acceptable range, clean the detector and check the Chamber value again. If the reading is still not within the acceptable range, immediately replace the detector.

Drift Compensation

Drift compensation uses software algorithms that identify and compensate for long-term changes in the data readings from each addressable smoke detector. These long-term changes in detector data readings are typically caused by dirt and dust accumulation inside the smoke chamber. Drift compensation performs the following functions:

- Allows a smoke detector to retain its original ability to detect actual smoke and resist false alarms, even as dirt and dust accumulate
- Reduces maintenance requirements by allowing the control panel to automatically perform the periodic sensitivity measurements required by NFPA Standard 72

The FACP software also provides filters to remove transient noise signals, usually caused by electrical interference.

Maintenance Alert

The software determines when the drift compensation for a detector reaches an unacceptable level that can compromise detector performance. When a detector reaches an unacceptable level, the control panel indicates a maintenance alert. Table 4.1 summarizes the three levels of maintenance alert:

Maintenance Level	FACP Status Displays	Indicates
Low Chamber Value	INUREP	A hardware problem in the detector
Maintenance Alert	DIRTY1	Dust accumulation that is near but below the allowed limit. <i>DIRTY 1</i> indicates the need for maintenance before the performance of the detector is compromised
Maintenance Urgent	DIRTY2	Dust accumulation above the allowed limit.

Table 4.1 Maintenance Alert Levels

Figure 4.1 illustrates a graphic representation of the maintenance levels:

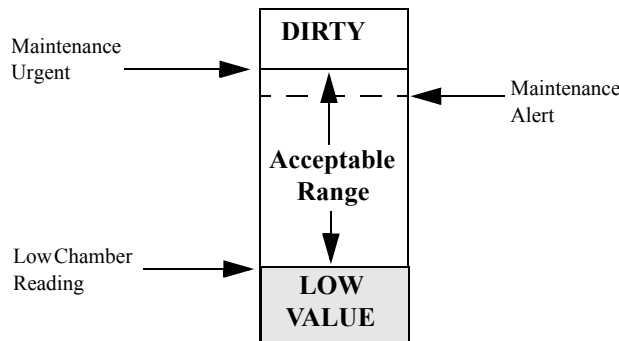

Figure 4.1 Diagram of Maintenance Levels

4.22.16 Time-Date

READ STATUS
1=TIME-DATE

Read Status Screen #6

The operator can view the daylight savings time and the month and week when daylight savings time will begin and end. Pressing 1 while viewing Read Status Screen #6 will display the following screens:

DAYLIGHT SAVINGS		↓
ENABLED	YES	
START MONTH	APR	
START WEEK	WEEK-1	

DAYLIGHT SAVINGS		↑
END MONTH	OCT	
END WEEK	LAST-W	

SECTION 5**Central Station Communications**

The control panel transmits zone and system status reports to Central Stations via the public switched telephone network. Two supervised telephone line connections are made to interface the control panel to the telephone lines. Two optional 7 foot telephone cords are available for this purpose and can be purchased separately.

The control panel supervises both telephone lines for proper voltage. A delay of two minutes will occur before a fault in either phone line connection is reported as a trouble. When a fault is detected, an audible trouble signal will sound, the yellow trouble LED will blink, the LCD display will indicate the phone line trouble and the trouble condition will be reported to the Central Station over the remaining operational phone line.

The control panel comes with line seizure capability provided for both the primary and secondary telephone line interfaces. Any time that the control panel needs to make a call to a Central Station, line seizure will disconnect any local premises phones sharing the same telephone line.

All transmissions to the Central Stations will be sent over the primary phone line. In the event of noisy phone lines, transmissions will be sent over the backup secondary phone line.

Two phone numbers must be programmed, the primary Central Station phone number and the secondary Central Station phone number. All system reports will be transmitted to the primary Central Station phone number. Reports will automatically be sent to the secondary Central Station phone number if attempts to transmit to the primary Central Station phone number are unsuccessful. If 10 total attempts to communicate are unsuccessful, a Communicator Failure report will be displayed. Note that as an option, *all* reports may also be sent to the secondary Central Station phone number.

The MS-9200UD meets NFPA 72 National Fire Code reporting requirements for: (a) the type of signal, (b) condition and (c) location of the reporting premises. The general priority reporting structure is:

1. Zone Alarms and Restores
2. Zone Troubles and Restores
3. System Troubles and Restores
4. 24-hour Test

The control panel is capable of reporting detailed messages depending upon the format in use. Table 5.1 shows the reporting structure for all formats.

Table 5.1 Format Selection

	Format	Format	Format	Format
Report	3+1/4+1/Standard 4+1 Express	3+1/4+1/Expanded	4+2/Standard 4+2 Express	4+2/Expanded
Alarm	SSS(S) A	SSS(S) A AAA(A) Z	SSSS AA2	SSSS AZ
Alarm Restore	SSS(S) RA	SSS(S) RA RARARA(RA) Z	SSSS RARA2	SSSS RAZ
Zone Trouble (Zone Open)	SSS(S) TZ	SSS(S) TZ TZTZTZ(TZ) Z	SSSS TZTZ2	SSSS TZZ
Zone Trouble Restore	SSS(S) RTZ	SSS(S) RTZ RTZRTZRTZ(RTZ) Z	SSSS RTZRTZ2	SSSS RTZZ
System Trouble	SSS(S) TS	SSS(S) TS TSTSTS(TS) Y	SSSS TSTS2	SSSS TSY
System Trouble Restore	SSS(S) RTS	SSS(S) RTS RTSRTSRTS(RTS) Y	SSSS RTSRTS2	SSSS RTSY
Zone Disable	SSS(S) DZ	SSS(S) DZ DZDZDZ(DZ) Z	SSSS DZDZ2	SSSS DZZ
Zone Disable Restore	SSS(S) RDZ	SSS(S) RDZ RDZRDZRDZ(RDZ) Z	SSSS RDZRDZ2	SSSS RDZZ
Low Battery	SSS(S) L	SSS(S) L LLL(L) L2	SSSS LL2	SSSS LL2
Low Battery Restore	SSS(S) RL	SSS(S) RL RLRLRL(RL) RL2	SSSS RLRL2	SSSS RLRL2
AC Loss	SSS(S) P	SSS(S) P PPP(P) P2	SSSS PP2	SSSS PP2
AC Loss Restore	SSS(S) RP	SSS(S) RP RPRPRP(RP) RP2	SSSS RPRP2	SSSS RPRP2
Fire Drill	SSS(S) FD	SSS(S) FD FDFDFD(FD) FD2	SSSS FDFD2	SSSS FDFD2
Fire Drill Restore	SSS(S) RFD	SSS(S) RFD RFDRFDRFD(RFD) RFD2	SSSS RFDRFD2	SSSS RFDRFD2
Supervisory Condition	SSS(S) V	SSS(S) V VVV(V) Z	SSSS VV2	SSSS VZ
Supervisory Condition Restore	SSS(S) RV	SSS(S) RV RVRVRV(RV) Z	SSSS RVRV2	SSSS RVZ
Test Report	SSS(S) X	SSS(S) X	SSSS XX2	SSSS XX2
Upload or Download	SSS(S) UD	SSS(S) UD	SSS UDUD2	SSS UDUD2

Refer to Table 5.2 for an explanation of each letter code in Table 5.1 . Refer to Table 5.3 for a list of compatible receivers.

Table 5.2 Format Selection Address Explanation

Where	
SSS or SSSS	= Subscriber ID
A	= Alarm (1st digit)
A2	= Alarm (2nd digit)
Z	= Zone Number
RA	= Alarm Restore (1st digit)
RA2	= Alarm Restore (2nd digit)
TZ	= Zone Trouble (1st digit)
TZ2	= Zone Trouble (2nd digit)
RTZ	= Zone Trouble Restore (1st digit)
RTZ2	= Zone Trouble Restore (2nd digit)
TS	= System Trouble (1st digit)
TS2	= System Trouble (2nd digit)
RTS	= System Trouble Restore (1st digit)
RTS2	= System Trouble Restore (2nd digit)
DZ	= Zone Disable (1st digit)
DZ2	= Zone Disable (2nd digit)
RDZ	= Zone Disable Restore (1st digit)
RDZ2	= Zone Disable Restore (2nd digit)
L	= Low Battery (1st digit)
L2	= Low Battery (2nd digit)
RL	= Low Battery Restore (1st digit)
RL2	= Low Battery Restore (2nd digit)
P	= AC Loss (1st digit)
P2	= AC Loss (2nd digit)
RP	= AC Loss Restore (1st digit)
RP2	= AC Loss Restore (2nd digit)
FD	= Fire Drill (1st digit)
FD2	= Fire Drill (2nd digit)
RFD	= Fire Drill Restore (1st digit)
RFD2	= Fire Drill Restore (2nd digit)
V	= Supervisory Condition (1st digit)
V2	= Supervisory Condition (2nd digit)
RV	= Supervisory Condition Restore (1st digit)
RV2	= Supervisory Condition Restore (2nd digit)
X	= Test Report (1st digit)
X2	= Test Report (2nd digit)
Y	= A trouble corresponding to the following:
7	= Ground Fault
8	= Low Battery
9	= not used
A	= Telco Primary Line Fault
B	= Telco Secondary Line Fault
C	= Main Bell Fault, Annunciator Bell
D	= Communication Fault to Primary Number
E	= Communication Fault to Secondary Number
F	= System Off Normal Fault/System Fault (Slave Operation, see Chapter 6)
UD	= Upload/download (1st digit)
UD2	= Upload/download (2nd digit)

Note: For Expanded Reporting, the control panel automatically adds the digit corresponding to the zone number and the second digit corresponding to any system trouble condition. Only the first digit is programmable.

5.1 Transmittal Priorities

The integral communicator transmits highest priority events first. Events, in terms of priority, are listed below in descending order:

1. Alarms (highest priority level)
 - ✓ Pull stations
 - ✓ Waterflow
 - ✓ Smoke detector
 - ✓ Other alarm types
2. Supervisory Zone
3. System Troubles
 - ✓ Zone disabled
 - ✓ Fire drill
 - ✓ AC fail (after delay)
 - ✓ Zonal faults
 - ✓ Earth fault
 - ✓ Low battery
 - ✓ Telephone line fault
 - ✓ Notification Appliance Circuits fault
 - ✓ Communication trouble
 - ✓ Annunciator trouble
 - ✓ System off normal
4. Restoral Reports
 - ✓ Zone alarm
 - ✓ Supervisory
 - ✓ Zone(s) enabled
 - ✓ Fire drill
 - ✓ AC
 - ✓ Zone fault
 - ✓ Earth
 - ✓ Battery
 - ✓ Telephone line
 - ✓ Notification Appliance Circuits
 - ✓ Communication
 - ✓ Annunciator trouble
 - ✓ System off normal
5. 24 Hour Test (lowest priority)

Red LEDs are provided on the circuit board to identify which telephone line is activated. Also, a green LED labeled *Kissoff* will turn on whenever the control panel has successfully transmitted reports to the Central Station. The *Kissoff* LED may turn on several times during communications with a Central Station.

The table below shows UL listed receivers which are compatible with the MS-9200UD.

Table 5.3 Compatible UL Listed Receivers

Format # (Addresses 16 & 42)	Ademco 685 (1)	Silent Knight 9000 (2)	ITI CS-4000 (3)	FBI CP220FB	Osborne Hoffman Models 1 & 2	Radionics 6000 (6)	Radionics 6500 (5)	Sescoa 3000R (7)	Surguard MLR-2 (9)
0	4+1 Ademco Express	✓			✓				✓
1	4+2 Ademco Express	✓			✓ (8)				✓
2	3+1/Standard/1800/2300	✓	✓	✓	✓ (4)	✓	✓	✓	✓
3	3+1/Expanded/1800/2300	✓	✓	✓	✓ (4)			✓	✓
4	3+1/Standard/1900/1400	✓	✓		✓ (4)			✓	✓
5	3+1/Expanded/1900/1400	✓	✓		✓ (4)			✓	✓
6	4+1/Standard/1800/2300	✓	✓	✓	✓ (4)		✓	✓	✓
7	4+1/Expanded/1800/2300	✓	✓		✓ (4)			✓	✓
8	4+1/Standard/1900/1400	✓	✓		✓ (4)			✓	✓
9	4+1/Expanded/1900/1400	✓	✓		✓ (4)			✓	✓
A	4+2/Standard/1800/2300	✓	✓	✓	✓ (4)		✓	✓	✓
B	4+2/Expanded/1800/2300	✓	✓		✓ (4)			✓	✓
C	4+2/Standard/1900/1400	✓	✓		✓ (4)			✓	✓
D	4+2/Expanded/1900/1400	✓	✓		✓ (4)			✓	✓
E	Ademco Contact ID	✓			✓				✓
F	Not Used								

1. With 685-8 Line Card with Rev. 4.4d software
2. With 9002 Line Card Rev. 9035 software or 9032 Line Card with 9326A software
3. Rev. 4.0 software
4. FBI CP220FB Rec-11 Line Card with Rev. 2.6 software and a memory card with Rev. 3.8 software
5. Model 6500 with Rev. 600 software
6. Mode 6000 with Rev. 204 software
7. With Rev. B control card at Rev. 1.4 software and Rev. C line card at Rev. 1.5 software
8. Model 2 only
9. Version 1.62 software

SECTION 6 Remote Site Upload/Download

The control panel may be programmed or interrogated off-site via the public switched telephone network. Any personal computer with Windows™ 95 or greater, with a 14.4 Kbaud compatible modem and Fire•Lite Upload/Download software kit P/N PK-CD, may serve as a Service Terminal. This allows download of the entire program or upload of the entire program, history file, walktest data, current status, system voltages, time and date.

CAUTION: After successfully downloading a program, make certain to perform the following steps:

1. Print out all programmed data via Print Mode or manually view programmed entries and compare to intended program data
2. Test all affected panel operations
3. Immediately correct any problems found

6.1 Downloading Program

The first time that the control panel is downloaded (whether initiated at the jobsite or remotely), a secret code is loaded in by a Service Terminal. Future upload or download requests cause verification of the secret code by the control panel before processing of data is allowed. If the secret code is not verified, the control panel will terminate the request.

While the control panel is communicating with the Service Terminal, one of the DACT's red phone line active LEDs will remain on steady. At the conclusion of a successful download, the green *Kissoff* LED will turn on steady for five seconds and the red phone line active LED will turn off.

In order to download the panel (whether initiated at the jobsite or remotely), the following must be true:

- ✓ The control panel must be in the Normal Mode of operation. Downloading is not possible if the panel is in any other mode
- ✓ There cannot be any active communications ongoing with a Central Station receiver
- ✓ All active events must be successfully 'kissed-off' by the Central Station(s). The communicator must be in a standby state with no new information waiting to be transmitted to a Central Station

Two basic communication mechanisms are supported as follows:

- Download with callback - the Service Terminal calls the control panel. The control panel answers the call, confirms the calling party then hangs up. The Service Terminal then waits for a callback from the control panel. After the control panel calls the Central Station and successfully reports that a request for downloading has been received, the control panel calls the Service Terminal back. Upon secret code verification, data transfers occur. When the data transfers are completed and the Service Terminal disconnects from the control panel, the panel calls the Central Station back to confirm either successful or unsuccessful results.
- Download with callback disabled - the Service Terminal calls the control panel. No hang-up sequence occurs. Data transfers proceed.

Note that Callback enable/disable is controlled by the master user at the Service Terminal on a per call basis.

Anytime a download with callback is initiated, the first thing the control panel will do is one of the following:

- contact the primary Central Station
- contact the primary and secondary Central Stations
- contact the first available Central Station phone number

Once contact has been established, the control panel will report a 'request for upload/download' message. Following 'kiss-off' of the request by the Central Station(s), the control panel will then call the appropriate Service Terminal and begin the downloading process.

Any time a download with callback disabled is initiated, the control panel and the Service Terminal will communicate and transfer data without first contacting a Central Station. When the data transfers are completed and the control panel disconnects from the Service Terminal, the control panel will call the Central Station and report one of the following conditions:

- Upload/download request received
- Upload and/or download request successful
- Upload/download failed

To prevent the 'request for upload/download' message(s) from being reported to the Central Station(s), make certain to disable all upload/download reports back to both Central Stations.

During the downloading process, the fire protection remains active. Should a system trouble or alarm condition occur, the control panel immediately terminates downloading and processes the trouble or alarm locally and transmits the information to the Central Station(s).

6.1.1 Security Features

Remote site upload and download with the control panel has been carefully designed to include key security features to ensure proper functionality. The key features are listed and explained below.

Secret Code Verification

A secret code is stored in the control panel by a Service Terminal to prevent unauthorized access. The secret code is created at the Service Terminal by the master user and cannot be viewed or changed by anyone other than a master user. Viewing of the secret code is prohibited at the control panel. Prior to allowing an upload or download of data, the control panel will verify the secret code transmitted by the Service Terminal.

Time-out at Control Panel

Upon answering an incoming call on either the primary or secondary Central Station phone line, the control panel will listen for a modem connection signal. If this signal is not received within 30 seconds, the control panel will disconnect the call. Upon successful connection (secret code verified and callback completed if applicable), if no communication occurs within five minutes, the panel will disconnect the call.

Callback to Service Terminal

Any time the control panel is requested to allow an upload or download, it will confirm the source of the incoming call, hang-up and call back the calling party (Service Terminal phone number).

Panel Identification Number

The panel identification number is typically used to identify the panel to the Service Terminal when the control panel calls the Service Terminal. If more than one call comes into the Service Terminal, the control panel ID number is used to sort out the calling parties.

Another use of this code allows for identical secret codes to be placed into multiple control panels at one jobsite, using the panel ID number to distinguish between the individual panels.

Error Checking

As each block of data is received by the control panel, it is checked for accuracy. If an error is detected, the block is retransmitted until correct, up to a maximum of four times. If the Secret Code is not verified and four errors occur, the call is disconnected and the report that the upload/download was not successful is called to the Central Station(s).

Central Station Acknowledge

There is an option, referred to as the 'callback' option, whereby the control panel will report to one or both Central Stations that a request for uploading or downloading has been received prior to processing the call. If the Central Station(s) does not acknowledge receipt of this request, uploading or downloading is prohibited. If acknowledged by the Central Station(s), another message is transmitted, informing the Central Station(s) that:

- Downloading was successful
- Uploading was successful
- Uploading/downloading was not successful

Central Station Data Protection

The primary and secondary Central Station phone numbers, communications format, account code, test time and programmable event codes are vital Central Station information. These blocks of data are protected from partial programming due to faulty phone connections, line noise and other errors. This prevents the panel from being confused due to a wrong phone number, account code, test time and most critical formatting errors.

6.2 Downloading Initiated at a Service Terminal

Before initiating the download procedure, make certain that the control panel is:

- ✓ *In Normal Mode*
- ✓ *Central Station communications are off*
- ✓ *The communicator is in the standby state (red phone line active LEDs are off and Kisoﬀ LEDs are off)*

Once the control panel accepts/answers an incoming call, the panel will:

1. Establish basic modem connection
2. Verify secret code and panel identification number
3. Verify callback vs. no callback request from the service terminal. If callback is requested, steps 4 through 9 will occur. If no callback is requested, only steps 8 and 9 will occur
4. Identify the Service Terminal location
5. Hang-up/disconnect call
6. Call the Central Station(s) and transmit a request for upload/download message (if programmed to do so). If this message is accepted, the control panel will proceed to the next step
7. Return call to Service Terminal
8. After security clearance, begin downloading
9. Upon completion of download, call Central Station(s) back and report either a successful download or failed upload/download message (if programmed to do so)

6.3 Uploading Initiated at a Service Terminal

Items that may be uploaded from the control panel to a Service Terminal are:

- All programmed data plus the real-time clock, time and date
- Entire Walktest data file
- Troubleshoot Mode system voltages
- Entire event History file
- Current system status

Uploading is possible at any time provided the following conditions are true:

- ✓ The control panel must be in the Normal Mode of operation. Uploading is not possible if the panel is in any other mode
- ✓ There cannot be any active communications ongoing with a Central Station receiver
- ✓ All active events must be successfully 'kissed-off' by the Central Station (the communicator must be in a standby state with no new information waiting to be transmitted to a Central Station)

Once an incoming call is accepted/answered by the control panel, the panel will:

1. Establish basic modem connection
2. Verify secret code and panel identification number
3. Verify callback vs. no callback request from the service terminal. If callback is requested, steps 4 through 9 will occur. If no callback is requested, only steps 8 and 9 will occur
4. Identify the Service Terminal location
5. Hang-up/disconnect call
6. Call the Central Station(s) and transmit a request for upload/download message (if programmed to do so). If this message is accepted, the control panel will proceed to the next step
7. Return call to Service Terminal
8. After security clearance, begin uploading
9. Upon completion of upload, call Central Station(s) back and report either a successful upload or failed upload/download message (if programmed to do so).

During the uploading process, the fire protection remains active. Should a system trouble or alarm condition occur, the control panel immediately terminates uploading and processes the trouble or alarm locally and transmits the information to the Central Station(s).

SECTION 7 Power Supply Calculations

7.1 Overview

This section contains instructions and tables for calculating power supply currents in alarm and standby conditions. This is a four-step process, consisting of the following:

1. Calculating the total amount of AC branch circuit current required to operate the system
2. Calculating the power supply load current for non-fire and fire alarm conditions and calculating the secondary (battery) load
3. Calculating the size of batteries required to support the system if an AC power loss occurs
4. Selecting the proper batteries for your system

7.2 Calculating the AC Branch Circuit

The control panel requires connection to a separate, dedicated AC branch circuit, which must be labeled **FIRE ALARM**. This branch circuit must connect to the line side of the main power feed of the protected premises. No other non-fire alarm equipment may be powered from the fire alarm branch circuit. The branch circuit wire must run

continuously, without any disconnect devices, from the power source to the control panel.

Overcurrent protection for this circuit must comply with Article 760 of the National Electrical Codes as well as local codes. Use 14 AWG (2.00 mm²) wire with 600 volt insulation for this branch circuit.

Use Table 7.1 , to determine the total amount of current, in AC amperes (A), that must be supplied to the system.

Table 7.1 AC Branch Circuit Requirements

Device Type	Number of Devices		Current Draw (AC amps)		Total Current per Device
MS-9200UD or MS-9200UDE	1	X	3.00 or 1.50	=	
CHG-75	[]	X	2.05	=	
CHG-120F	[]	X	2.00	=	
	[]	X	[]	=	
Sum Column for AC Branch Current Required				=	

7.3 Calculating the System Current Draw

7.3.1 Overview

The control panel must be able to power all internal and external devices continuously during the non-fire alarm condition. To calculate the non-fire alarm load on the system power supply when primary power is applied, use Calculation Column 1 in Table 7.3 on page 167. The control panel must support a larger load current during a fire alarm condition. To calculate the fire alarm load on the power supply, use Calculation Column 2 in Table 7.3 on page 167. The secondary power source (batteries) must be able to power the system during a primary power loss. To calculate the non-fire alarm load on the secondary power source, use Calculation Column 3 in Table 7.3 on page 167.

When calculating current draw and the battery size, note the following:

- ‘Primary’ refers to the main power source for the control panel
- ‘Secondary’ refers to the control panel’s backup batteries
- All currents are given in amperes (A). Table 7.2 shows how to convert milliamperes and microamperes to full amperes.

Table 7.2 Converting to Full Amperes

To convert...	Multiply	Example
Milliamperes (mA) to amperes (A)	mA x 0.001	3 mA x 0.001 = 0.003A
Microamperes (µA) to amperes (A)	µA x 0.000001	300 µA x 0.000001 = 0.0003 A

7.3.2 How to Use Table 7.3 on page 167 to Calculate System Current Draw

Use Table 7.3 on page 167 to calculate current draws as follows:

1. Enter the quantity of devices in all three columns
2. Enter the current draw where required. Refer to the Fire•Lite Device Compatibility Document for compatible devices and their current draw
3. Calculate the current draws for each in all columns
4. Sum the total current for each column
5. Copy the totals from Column 2 and Column 3 to Table 7.4 on page 168

Following are the types of current that can be entered into Table 7.3 on page 167:

- ✓ **Calculation Column 1** - The primary supply current load that the control panel must support during a non-fire alarm condition, with AC power applied.
- ✓ **Calculation Column 2** - The primary supply current load that the control panel must support during a fire alarm condition, with AC power applied.
- ✓ **Calculation Column 3** - The standby current drawn from the batteries in a non-fire alarm condition during a loss of AC power.

Table 7.3 contains columns for calculating current draws. For each column, calculate the current and enter the total (in amperes) in the bottom row. When finished, copy the totals from Calculation Column 2 and Calculation Column 3 to Table 7.4 on page 168.

Table 7.3 System Current Draw Calculations

Device Type	Calculation Column 1 Primary, Non-Fire Alarm Current (amps)			Calculation Column 2 Primary, Fire Alarm Current (amps)			Calculation Column 3 Secondary, Non-Fire Alarm Current (amps)		
	Qty	X[current draw]=	Total	Qty	X [current draw] =	Total	Qty	X[current draw]=	Total
Main Circuit Board	[]	X[0.300]=	0.300	[]	X[0.325]=	0.325	[]	X[0.255]=	0.255
ACM-8RF	[]	X[0.030]=		[]	X[0.158]=		[]	X[0.030]=	
ACM-16ATF	[]	X[0.040]		[]	X[0.056] ² =		[]	X[0.040]=	
ACM-32AF	[]	X[0.002]		[]	X[0.018] ² =		[]	X[0.002]=	
AEM-16ATF	[]	X[0.040]		[]	X[0.056] ² =		[]	X[0.040]=	
AEM-32AF	[]	X[0.025]		[]	X[0.065] ² =		[]	X[0.025]=	
AFM-16ATF	[]	X[0.040]		[]	X[0.075]=		[]	X[0.040]=	
AFM-32AF	[]	X[0.040]		[]	X[0.056] ³ =		[]	X[0.040]=	
AFM-16AF	[]	X[0.002]		[]	X[0.018]=		[]	X[0.002]=	
UDACT-F	[]	X[0.064]		[]	X[0.064]=		[]	X[0.025]=	
LDM-32F	[]	X[0.005]=		[]	X[0.011] ⁴ =		[]	X[0.005]=	
LDM-E32F	[]	X[] ⁵ =		[]	X[]=		[]	X[]=	
LCD-80F	[]	X[] ⁵ =		[]	X[]=		[]	X[]=	
4XTMF	[]	X[] ⁵ =		[]	X[]=		[]	X[]=	
Power Supervision Relays ⁶	[]	X[0.025]=		[]	X[0.025]=		[]	X[0.025]=	
CP350 & CP355	[]	X[0.00030]=		maximum alarm draw for all devices	0.400	[]	X[0.00030]=		
SD350 & SD355	[]	X[0.00030]=	[]			X[0.00030]=			
SD350T & SD355T	[]	X[0.00030]=	[]			X[0.00030]=			
AD350 & AD355	[]	X[0.00030]=	[]			X[0.00030]=			
H350 & H355	[]	X[0.00030]=	[]			X[0.00030]=			
H350R & H355R	[]	X[0.00030]=	[]			X[0.00030]=			
H355H1	[]	X[0.00030]=	[]			X[0.00030]=			
D350P	[]	X[0.00030]=	[]			X[0.00030]=			
D350RP	[]	X[0.00030]=	[]			X[0.00030]=			
B501BH & B501BHT ⁷	[]	X[0.001]=	[]			X[0.001]=			
B224RB Relay Base	[]	X[0.00050]=	[]			X[0.00050]=			
B224BI Isolator Base	[]	X[0.00045]=	[]			X[0.00045]=			
MMF-300	[]	X[0.00040]=	[]			X[0.00040]=			
MMF-300-10	[]	X[0.00350]=	[]			X[0.00350]=			
MDF-300	[]	X[0.00075]=	[]			X[0.00075]=			
MMF-301	[]	X[0.000375]=	[]			X[0.000375]=			
MMF-302	[]	X[0.00027]=	[]			X[0.00027]=			
MMF-302-6	[]	X[0.00200]=	[]			X[0.00200]=			
BG-12LX	[]	X[0.00023]=	[]			X[0.00023]=			
CMF-300	[]	X[0.00039]=	[]			X[0.00039]=			
CMF-300-6	[]	X[0.00225]=	[]	X[0.00225]=					
CRF-300	[]	X[0.00027]=	[]	X[0.00027]=					
CRF-300-6	[]	X[0.00145]=	[]	X[0.00145]=					
I300	[]	X[0.00040]=	[]	X[0.00040]=					
NAC #1 ⁸	[]	X[]=	[]	X[]=					
NAC #2	[]	X[]=	[]	X[]=					
NAC #3	[]	X[]=	[]	X[]=					
NAC #4	[]	X[]=	[]	X[]=					
Current Draw from TB3 (nonalarm) ⁹	[]	X[]=	[]	X[]=					
Sum each column¹⁰ for totals		Primary Non-Alarm =		Primary Alarm =			Secondary Non-Alarm =		

Table Footnote

- All eight ACM-8RF relays activated on a single module.
- All annunciator LEDs on
- LDM-32F with LEDs on
- If using the Reverse Polarity Alarm output, add 0.005 amps; if using the Reverse Polarity Trouble output, add another 0.005 amps.
- Refer to the Device Compatibility Document for standby current.
- Must use compatible listed Power Supervision Relay.
- Maximum alarm current for each sounder base is 0.015 amps which must be supplied by aux. 24VDC source.
- Current limitation of Terminal TB3 & TB4 circuits is 2.5 amps per NAC.
- The total standby current must include both the nonresettable/resettable (TB1 Terminals 1 & 2) and resettable (TB1 Terminals 3 & 4) power. Caution must be taken to ensure that current drawn from these outputs during alarm does not exceed maximum ratings specified. Current limitations of TB3 & TB4 circuits is 2.5 amps per NAC output and 0.5 amps per auxiliary power output
- Total current draw listed above cannot exceed 6.0 amps.

7.4 Calculating the Battery Size

Use Table 7.4 to calculate the total Standby and Alarm load in ampere hours (AH). This total load determines the battery size (in AH), required to support the control panel under the loss of AC power. Complete Table 7.4 as follows:

1. Enter the totals from Table 7.3 on page 167, Calculation Columns 2 and 3 where shown
2. Enter the NFPA Standby and Alarm times (refer to ‘NFPA Requirements’ below)
3. Calculate the ampere hours for Standby and Alarm, then sum the Standby and Alarm ampere hours
4. Multiply the sum by the derating factor of 1.2 to calculate the proper battery size (in AH)
5. Write the ampere hour requirements on the Protected Premises label located inside the cabinet door

Table 7.4 Total Secondary Power Requirements at 24 VDC

Secondary Standby Load (total from Table 7.3 Calculation Column 3) []	Required Standby Time (24 or 60 hours) X[]	= AH
Primary Alarm Load (total from Table 7.3 Calculation Column 2) []	Required Alarm Time (for 5 min., enter 0.084, for 10 min., enter 0.168) X[]	= AH
Sum of Standby and Alarm Ampere Hours		= AH
Multiply by the Derating Factor		X 1.2
Battery Size, Total Ampere Hours Required		= AH

7.4.1 NFPA Battery Requirements

- NFPA 72 Local and Proprietary Fire Alarm Systems require 24 hours of standby power followed by 5 minutes in alarm
- NFPA 72 Central, Auxiliary and Remote Station Fire Alarm Systems require 60 hours of standby followed by 5 minutes in alarm. Batteries installed in a system powered by a generator need to provide at least 4 hours of standby power

7.4.2 Selecting and Locating Batteries

Select batteries that meet or exceed the total ampere hours calculated in Table 7.4 . The control panel can charge batteries in the 7 AH to 18 AH range. The control panel cabinet is capable of housing batteries up to 18 AH. Batteries larger than 18 AH require a UL listed external battery charger and cabinet such as the BB-26, BB-55F or other UL listed external battery cabinet.

APPENDIX A Software Zones

A.1 Correlations

Setup and configuration of an addressable system is different than a conventional system. In a conventional system, assignment of input devices (smoke detectors, pull stations, heat detectors, etc.) to zones is accomplished through wiring. The wiring is direct from clearly marked panel terminals to any device assigned to a particular zone. Connection of output devices (horns, bells, strobes, etc.) in a conventional system is accomplished by direct wiring of the output devices to Notification Appliance Circuit terminals.

In an addressable system, a minimum of a single pair of wires (SLC communication loop) is used to connect all addressable input and output devices. Communications between the FACP (Fire Alarm Control Panel) and all addressable devices takes place over the wire pair which originates from the FACP. Software programming is used to configure the system as opposed to direct wiring. Zone assignments are created via software means, hence the term *software zones*.

Setup of an MS-9200UD software zone is accomplished by panel programming. Each addressable device can be assigned to a maximum of five software zones. Each software zone, however, may have from 1 to 99' addressable input devices assigned to it and from 1 to 99' addressable output devices assigned to it.

Monitor and control modules comprise one group of 99' addresses, with each module having a unique address from 1 to 99'. Detectors comprise a separate group of 99' addresses, each detector having a unique address from 1 to 99' in its group. Be careful not to duplicate addresses within any one group (modules and detectors). Refer to the following page for an example of zoning.

In the example on the following page:

- Zone 01 has the following addressable devices assigned to it:
 - ✓ SD350 smoke detectors with addresses 01 and 02
 - ✓ MMF-300 monitor module with address 01
 - ✓ MMF-302 monitor module with address 02 and 03
 - ✓ CMF-300 control modules with addresses 05, 06, 07, 09 and 13
- Zone 02 has the following addressable devices assigned to it:
 - ✓ MMF-302 monitor module with addresses 02 and 03
 - ✓ CP350 smoke detectors with addresses 03 and 04
 - ✓ CMF-300 control modules with addresses 08, 09 and 10
- Zone 03 has the following addressable devices assigned to it:
 - ✓ SD350 smoke detectors with addresses 05, 06 and 07
 - ✓ MMF-302 control module with address 04
 - ✓ CMF-300 control modules with addresses 09, 11 and 12

The example points out some of the key assignment features of the MS-9200UD. Addresses of detectors are not duplicated. Addresses of monitor and control modules are not duplicated. The control module with address 09 is assigned to three software zones (providing floor above and floor below). Be careful to properly plan the installation prior to installing any devices.

Correlation of Input and Output Zones

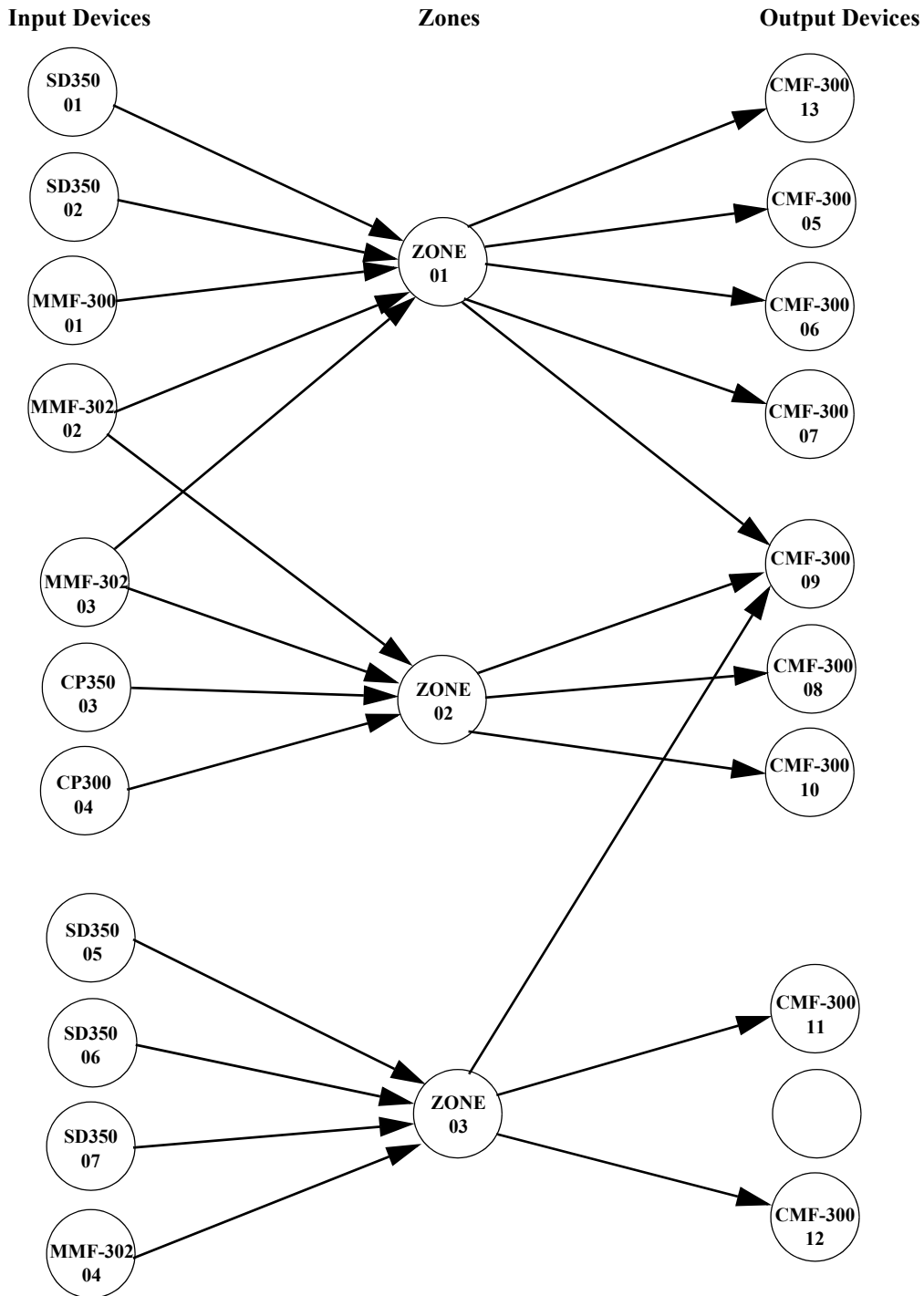

The zone correlations which are shown graphically above are also presented in Table A.1 on page 171 and Table A.2 on page 172.

Table A.1 Detector Programming Sheet Example

DETECTOR ZONE ASSIGNMENT							
Address	Device Type	Zone Number	ADJ/NOUN	Address	Device Type	Zone Number	ADJ/NOUN
01	SD350	1	FIRST HALL	51			
02	SD350	1	ELEV. LOBBY	52			
03	CP350	2	2ND FLOOR	53			
04	CP350	2	ROOM 210	54			
05	SD350	3	3RD FLOOR	55			
06	SD350	3	MEZZANINE	56			
07	SD350	3	MECH. ROOM	57			
08				58			
09				59			
10				60			
11				61			
12				62			
13				63			
14				64			
15				65			
16				66			
17				67			
18				68			
19				69			
20				70			
21				71			
22				72			
23				73			
24				74			
25				75			
26				76			
27				77			
28				78			
29				79			
30				80			
31				81			
32				82			
33				83			
34				84			
35				85			
36				86			
37				87			
38				88			
39				89			
40				90			
41				91			
42				92			
43				93			
44				94			
45				95			
46				96			
47				97			
48				98			
49				99			
50							

Table A.2 Module Programming Sheet Example

MONITOR/CONTROL MODULE ZONE ASSIGNMENT							
Address	Device Type	Zone Number	ADJ/NOUN	Address	Device Type	Zone Number	ADJ/NOUN
01	MMF-300	1		51			
02	MMF-302	1, 2		52			
03	MMF-302	1, 2		53			
04	MMF-302	3		54			
05	CMF-300	1		55			
06	CMF-300	1		56			
07	CMF-300	1		57			
08	CMF-300	2		58			
09	CMF-300	1, 2, 3		59			
10	CMF-300	2		60			
11	CMF-300	3		61			
12	CMF-300	3		62			
13	CMF-300	1		63			
14				64			
15				65			
16				66			
17				67			
18				68			
19				69			
20				70			
21				71			
22				72			
23				73			
24				74			
25				75			
26				76			
27				77			
28				78			
29				79			
30				80			
31				81			
32				82			
33				83			
34				84			
35				85			
36				86			
37				87			
38				88			
39				89			
40				90			
41				91			
42				92			
43				93			
44				94			
45				95			
46				96			
47				97			
48				98			
49				99			
50							

Table A.3 Blank Detector Programming Sheet - 1 of 2

DETECTOR ZONE ASSIGNMENT							
Address	Device Type	Zone Number	ADJ/NOUN	Address	Device Type	Zone Number	ADJ/NOUN
01				51			
02				52			
03				53			
04				54			
05				55			
06				56			
07				57			
08				58			
09				59			
10				60			
11				61			
12				62			
13				63			
14				64			
15				65			
16				66			
17				67			
18				68			
19				69			
20				70			
21				71			
22				72			
23				73			
24				74			
25				75			
26				76			
27				77			
28				78			
29				79			
30				80			
31				81			
32				82			
33				83			
34				84			
35				85			
36				86			
37				87			
38				88			
39				89			
40				90			
41				91			
42				92			
43				93			
44				94			
45				95			
46				96			
47				97			
48				98			
49				99			
50							

Table A.4 Blank Module Programming Sheet - 1 of 2

MONITOR/CONTROL MODULE ZONE ASSIGNMENT							
Address	Device Type	Zone Number	ADJ/NOUN	Address	Device Type	Zone Number	ADJ/NOUN
01				51			
02				52			
03				53			
04				54			
05				55			
06				56			
07				57			
08				58			
09				59			
10				60			
11				61			
12				62			
13				63			
14				64			
15				65			
16				66			
17				67			
18				68			
19				69			
20				70			
21				71			
22				72			
23				73			
24				74			
25				75			
26				76			
27				77			
28				78			
29				79			
30				80			
31				81			
32				82			
33				83			
34				84			
35				85			
36				86			
37				87			
38				88			
39				89			
40				90			
41				91			
42				92			
43				93			
44				94			
45				95			
46				96			
47				97			
48				98			
49				99			
50							

APPENDIX B Default Programming

The following table provides a list of the programming options and their factory default settings.

Program Option	Factory Default	Program Option	Factory Default
Detector Programming	Not Installed	Daylight Savings	Yes
Detector Type	Smoke-Photo	Month Start Daylight Savings	April
Detector Verification	Off	Week Start Daylight Savings	1st Week
Detector Walktest	Yes	Month End Daylight Savings	October
Detector PAS	No	Week End Daylight	Last Week
Detector Presignal	No	Verification	No
Detector Zone Assign.	000 only	(future)	
Detector Adj/Noun	none	PAS Timer	0
Module Programming	Not Installed	Presignal Timer	0
Module Type	Monitor	Waterflow Retard Timer	0
Module Walktest	Yes	NAC 1, 2, 3 & 4 Enable	Enabled
Module PAS	No	NAC 1, 2, 3 & 4 Silenceable	Yes
Module Presignal	No	NAC 1, 2, 3 & 4 Type	Bell
Module Zone Assign.	000 only	NAC 1, 2, 3 & 4 Sync Type	System Sensor
Module Adj/Noun	none	NAC 1, 2, 3 & 4 Autosilence	0
Zone 0 Enable	Enabled	NAC 1, 2, 3 & 4 Coding	Steady
Zone 1 Enable	Enabled	NAC 1, 2, 3 & 4 Zones	Zone 000 only
Zone 2 Enable	Enabled	NAC 1, 2, 3 & 4 Silence Inhibit	0
Zone 3 Enable	Enabled	Relay 1	Alarm
.....through.....	Relay 2	Trouble (fixed)
Zone 96 Enable	Enabled	Relay 3	Supervisory
Zones 97, 98 & 99	Enabled	(future)	No
(future)		Annunciator Terminal Mode	No
Loop Style	Style 4	Annunciator ACS Mode	
Loop Protocol	CLIP	UDACT	No
Trouble Reminder	Off	ACS Installed	No
Banner	Fire•Lite	Onboard DACT	No
Time Format	12 Hr	Printer-PC	No
Hours Setting	12	Printer Baud	9600
Minutes Setting	00		
Second Settings	00		
AM-PM Setting	AM		
Month Setting	01		
Day Setting	01		
Year Setting	00		

APPENDIX C NFPA Standard-Specific Requirements

The Fire•Lite MS-9200UD has been designed for use in commercial, industrial and institutional applications and meets the requirements for service under the National Fire Protection Association (NFPA) Standards outlined in this Appendix. The minimum system components required for compliance with the appropriate NFPA standard are listed below:

MS-9200UD Control Panel

Contains the main control board, cabinet (backbox and door), main power supply transformer and power supply.

Batteries

Refer to "Power Supply Calculations" on page 165, for Standby Power Requirements.

Initiating Devices

Connected to one of the control panel's Initiating Device Circuits.

Notification Appliances

Connected to the control panel's Notification Appliance Circuits via a control module.

The following additional equipment is needed for compliance with the NFPA 72 standards listed below:

NFPA 72 NATIONAL FIRE ALARM STANDARDS FOR:

NFPA 72 Central Station Service (Protected Premises Unit) or Remote Station Service

Onboard Digital Alarm Communicator Transmitter for connection to a compatible listed Central Station DACR or Protected Premises Receiving Unit. This unit must be installed as outlined in "Digital Alarm Communicator/Transmitter" on page 17.

OR

4XTMF Transmitter Module for connection to the Fire•Lite RS82 Remote Station Receiver. See Figure C.2, "Remote Station Connection Using 4XTMF Module," on page 178, for installation instructions for this unit.

NFPA 72 Auxiliary Fire Alarm System

4XTMF Transmitter Module for connection to a compatible listed Local Energy Municipal Box. This unit must be installed as illustrated in the section titled "4XTMF Transmitter Module Installation" on page 38 and as outlined in Figure C.1, "Municipal Box Connected to 4XTMF Transmitter Module," on page 177.

NFPA 72 Proprietary Fire Alarm System

MS-9200UD Alarm, Trouble and Supervisory contacts connected to Transmitter(s). See Figure C.3, "Proprietary Protective Signaling System," on page 179, for installation instructions for this unit.

NFPA 72 Auxiliary Fire Alarm System

All connections are power-limited and supervised. This application is not suitable for separate transmission of sprinkler supervisory or trouble conditions.

Notes:

1. 3 ohms maximum loop resistance allowed for wiring from control panel to Municipal Box.
2. Cut JP3 on the MS-9200UD main circuit board to supervise placement of 4XTMF module and circuit.
3. Cut JP2 on the MS-9200UD main circuit board to enable FACP Supervisory relay.
4. Refer to "4XTMF Transmitter Module Installation" on page 38 for detailed information.

Figure C.1 Municipal Box Connected to 4XTMF Transmitter Module

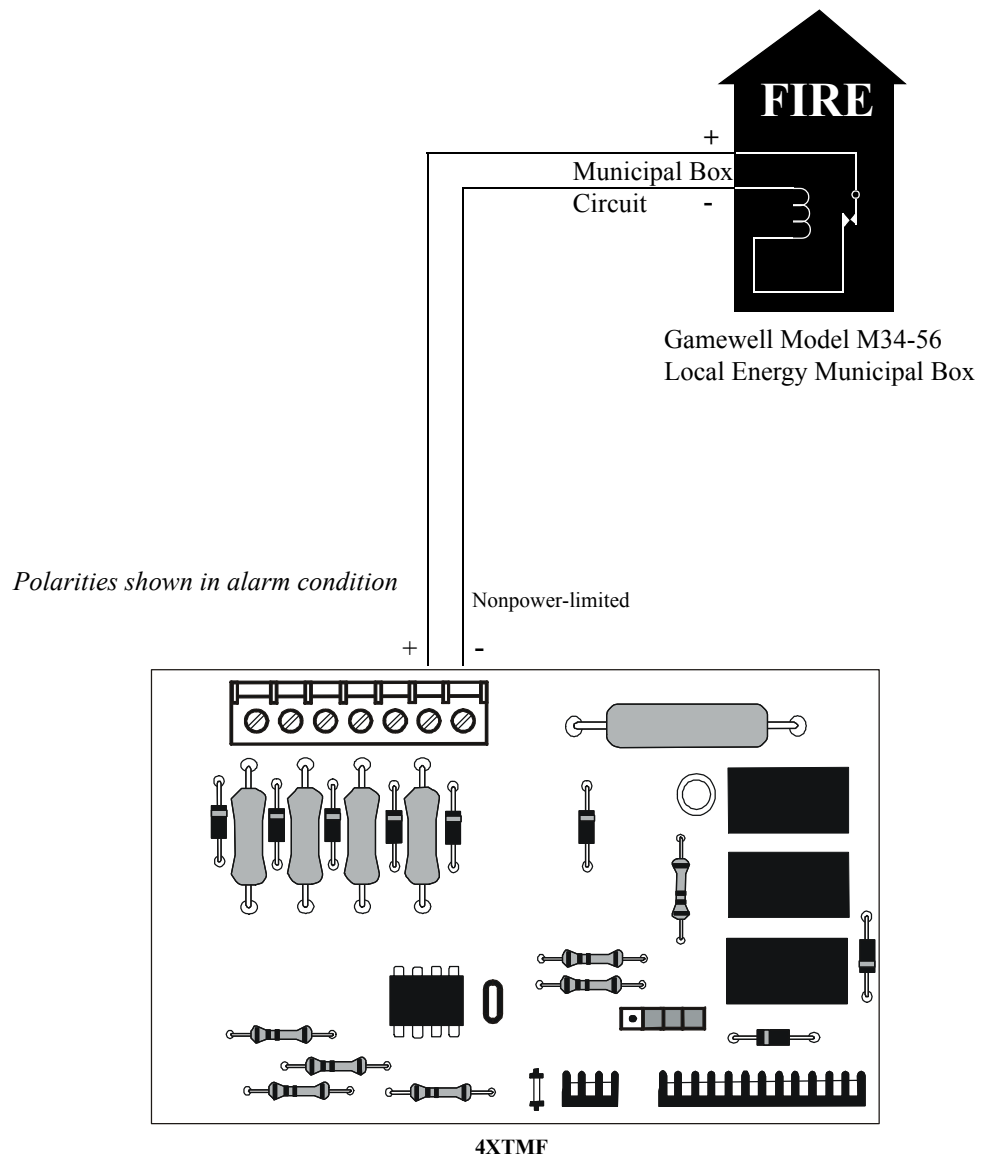

Figure C.1 Municipal Box Connected to 4XTMF Transmitter Module

NFPA 72 Remote Station Protective Signaling System

Notes:

1. Cut Jumper JP3 on the MS-9200UD main circuit board to supervise placement of the 4XTMF module.
2. Refer to "4XTMF Transmitter Module Installation" on page 38 for detailed information.

Fire•Lite RS82 Remote Station Receiver UL listed.
Refer to Fire•Lite Instruction Manual for Remote Station Receiver Model RS82.

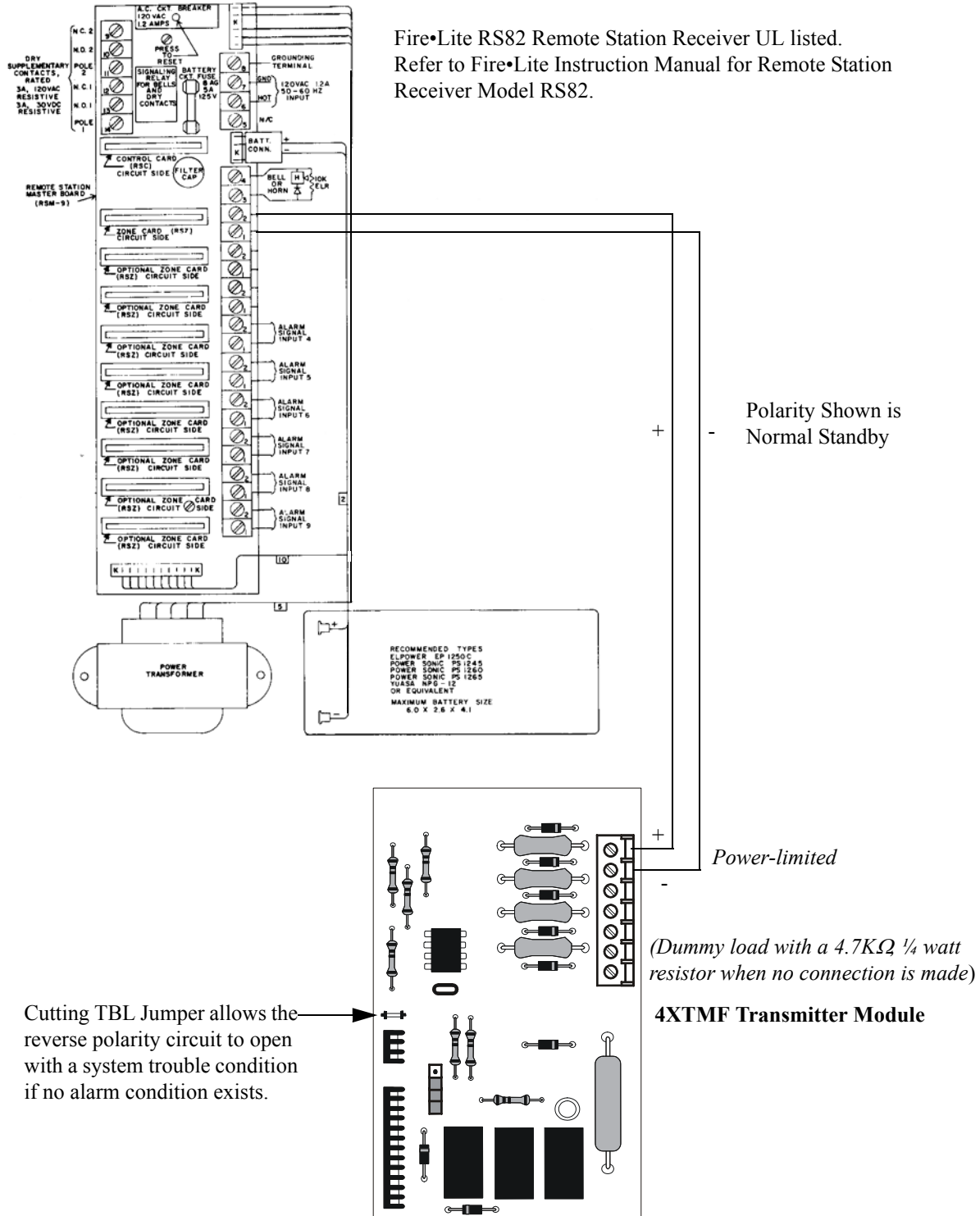

Figure C.2 Remote Station Connection Using 4XTMF Module

NFPA 72 Proprietary Protective Signaling Systems

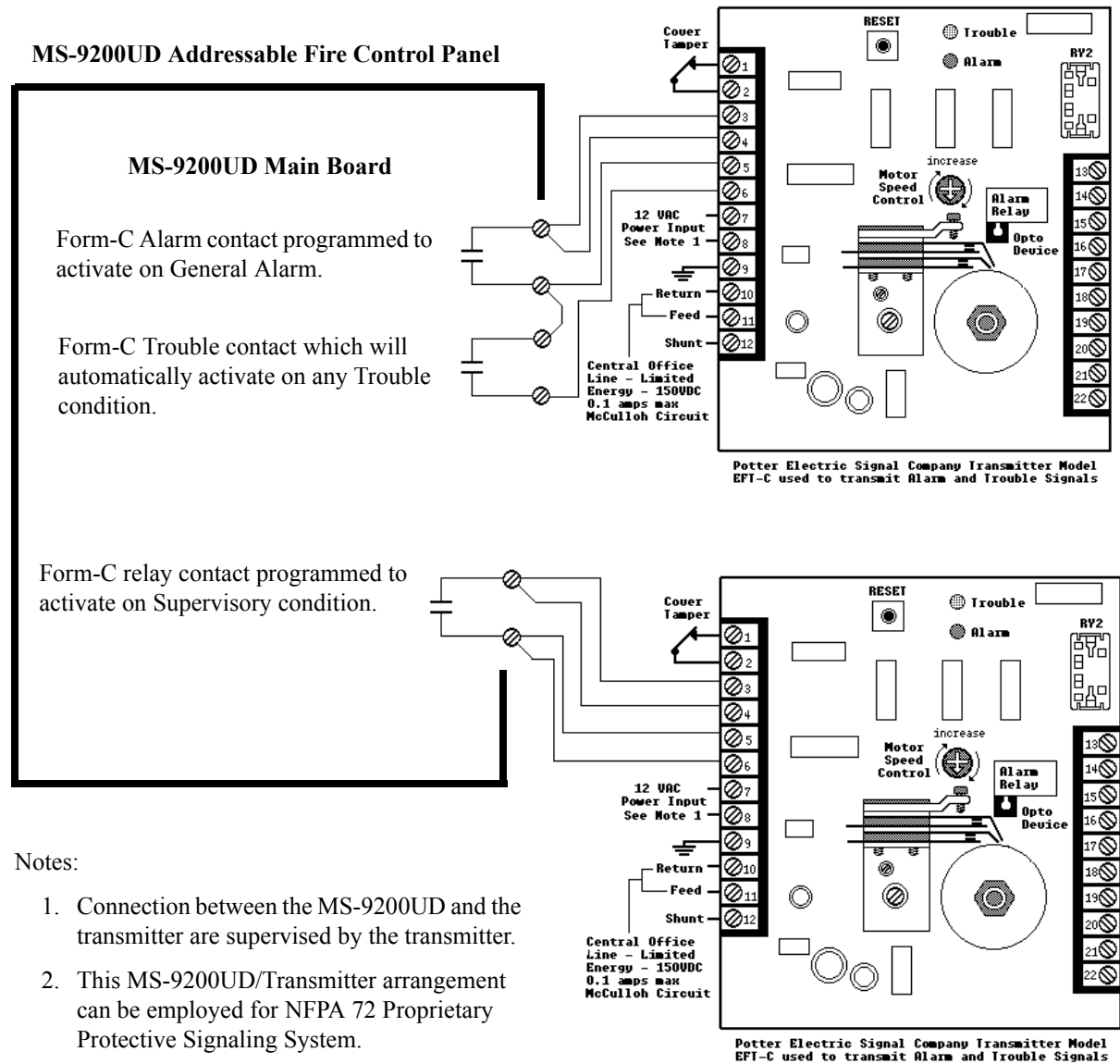

Figure C.3 Proprietary Protective Signaling System

APPENDIX D Wire Requirements

T-tapping of the SLC loop wiring is allowed for 2-wire (Style 4) configurations. The total resistance of any branch cannot exceed 40 ohms. The total wire length of all branches cannot exceed 10,000 feet (3,000 m).

Connecting external system accessories to the MS-9200UD main circuits must be carefully considered to ensure proper operation. It is important to use the correct type of wire, wire gauge and wire run length for each MS-9200UD circuit. Reference the chart below to specify wire requirements and limitations for each MS-9200UD circuit.

Note: If the SLC loop is to be run in conduit with Notification Appliance Circuits, the risk of encountering problems can be greatly reduced by exclusively employing electronic sounders (such as MA/SS-24D) instead of more electronically noisy notification appliances such as electromechanical bells or horns.

Table D.1 MS-9200UD Wire Specifications

CIRCUIT CONNECTIONS		WIRE REQUIREMENTS		
Circuit Type	Circuit Function	Wire Type and Limitations	Recommended Max. Distance Feet (meters)	Wire Gauge and Compatible Brands
SLC loop (power-limited)	Connects to Addressable Devices	Twisted, shielded pair, 40 ohms maximum per length of Style 6 and 7 loops. 40 ohms per branch maximum for Style 4 loops ¹	10,000 (3,000 m) 8,000 (2,400 m) 4,875 (1,450 m) 3,225 (980 m)	12 AWG (3.25 mm ²): Genesis 4410, Signal 98230, Belden 9583, WPW999 14 AWG (2.00 mm ²): Genesis 4408 & 4608, Signal 98430, Belden 9581, WPW995 16 AWG (1.30 mm ²): Genesis 4406 & 4606, Signal 98630, Belden 9575, WPW991 <u>Direct Burial Cable</u> Isotec NP713110VNQ-S 18 AWG (0.75 mm ²): Genesis 4402 & 4602, Signal 98300, Belden 9574, WPW975 <u>Direct Burial Cable</u> Isotec NP714110VNQ-S
		Untwisted, unshielded pair	3,000 (900 m)	12-18 AWG (3.25 - 0.75 mm ²)
ACS/TERM (EIA-485) (power-limited)	Connects to annunciator modules	Twisted, shielded pair with a characteristic impedance of 120 ohms	6,000 (1,800 m)	18 AWG (0.75 mm ²)
EIA-232 (power-limited)	connects to remote printer and PC computer	Twisted, shielded pair	50 (15 m)	18 AWG (0.75 mm ²) minimum
MMF-300 and MMF-301 (power-limited)	Initiating Device Circuit	Maximum loop wire resistance is 40 ohms for the MMF-300 and 20 ohms for the MMF-301	2,500 (760 m)	12-18 AWG (3.25 - 0.75 mm ²)
MMF-302 (power-limited)	Initiating Device Circuit	No more than a 2.4 volt drop allowed at end of circuit. Maximum loop wire resistance is 25 ohms	2,500 (760 m)	12-18 AWG (3.25 - 0.75 mm ²)
CMF-300 (power-limited)	Notification Appliance Circuit	In alarm, no more than a 1.2 volt drop allowed at end of circuit	Distance limitation set by 1.2 volt maximum line drop	12-18 AWG (3.25 - 0.75 mm ²)
24 VDC filtered resettable (power-limited)	Connects to 4-wire smoke detectors	No more than 1.2 volt drop allowed from supply source to end of any branch	Distance limitation set by 1.2 volt maximum line drop	12-18 AWG (3.25 - 0.75 mm ²)
24 VDC nonresettable (power-limited)	Connects to control modules, annunciators and accessories	No more than 1.2 volt drop allowed from supply source to end of any branch	Distance limitation set by 1.2 volt maximum line drop	12-18 AWG (3.25 - 0.75 mm ²)
CHG-120F or CHG-75	Remote secondary power source	12 AWG (3.25 mm ²) in conduit	20 (6 m)	12-18 AWG (3.25 - 0.75 mm ²)

Table Footnote

1. When using untwisted, unshielded wire, full conduit is recommended for optimum EMI/RFI protection.

Index

Numerics

- 24 Hour Test Time 107
- 300 Series addressable devices 20
- 4XTMF module 177, 178
 - coil resistance 38
 - current 38
 - installation 38
 - installation steps 39
 - see also Transmitter Module 14, 21
 - supervisory relay config. 39
 - voltage 38

A

- AC Branch Circuit
 - calculations 165
- AC Loss Delay 88
- AC Power 31
 - current 14
 - current, maximum 31
 - voltage 14
 - wiring 14, 31
- Account Code 106
- Acknowledge/Step 16, 130
- ACM 23
- ACM LED annunciator 43
- ACM Series
 - see also annunciator 23
- ACM-16ATF Annunciator 23
- ACM-32AF Annunciator 23
- ACM-8RF 14
 - contact rating 41
 - mounting to BRKT-9600 42
 - see also Relay Control Module 41
- ACS LED annunciator 14
- AD350 18
- AD355 18
- add Detector 50
- add Module 60
- addressable 12
- addressable detectors
 - see also detectors 14
- Addressable Device Accessories 20
- addressable modules 19
 - see also modules 13
- addressing
 - annunciators 43
 - see also device addressing 81
 - see also module or detector addressing 19
- Adjective
 - control module 74
 - list 57
 - monitor module 67
 - multiple entries 59
- AEM-16ATF Annunciator 23
- AEM-32AF Annunciator 23
- AFM annunciator 43
- AFM-16AF Annunciator 23
- AFM-16ATF Annunciator 23

- AFM-32AF Annunciator 23
- Alarm 134
- Alarm Silence 16, 130
- alarm verification 13, 54, 137, 141
- annunciator 23
 - ACM 14, 43
 - ACM-8RF 14
 - LCD-80F 14
 - LDM Graphic 14
- annunciator addressing 43
- annunciator, graphic
 - see also LDM Series 24
- annunciator, remote
 - see also LCD-80F 24
- Automatic Test Operation 137
- Autoprogramming 13, 45, 49
- Autosilence 13, 140
 - NAC 91
- auxiliary DC power 31
- B**
- backbox 18
 - see also cabinet 30
- Backup Reporting 104
- Banner 82
 - setting 83
- battery 18
 - cable connection 31
 - charger 17
 - charger capacity 14
 - Charging Circuit 14
 - see also secondary power 14, 31
- battery box 22
- battery charger 22
 - disable 14
 - external 22
- baud rate 117
- BB-55F
 - see also battery box 18, 22
- BG-10LX
 - see also manual pull station 20
- BG-12LX
 - see also manual pull station 20
- BRKT-9600
 - bracket installation 41, 42
- C**
- C304 Control/Relay Module 20
- cabinet 18
 - dimensions 29, 30
- cabinet mounting 27
- Calculate System Current Draw 166
- Calculating the Battery Size 168
- Callback 161
- Canadian Option 82, 95
- Central Station 103, 162
 - account code 106
 - communications 155
 - phone number 107

Index

- Phone Numbers 105
 - report style 116
- CHG-120F
 - see also battery charger 22
 - see also remote battery charger 14
- CHG-75
 - see also battery charger 22
 - see also remote battery charger 14
- Classic Loop Interface Protocol 81
- Class A 19, 32
- Class B 19, 32
 - NAC wiring 33
- CLIP mode
 - see also Classic Loop Interface Protocol 81
- Clock Format 85
- CMF-300 control module 19
- Coded Operation 138
- Coding
 - NAC 91
- coding
 - two stage operation 92
- communications format 108, 109
- Control Buttons 130
- control module 19
 - description display 76
 - display 70
 - edit 70
 - enable/disable 71
 - noun 75
 - noun/adjective 73, 74
 - silenceable 73
 - type 72
 - type codes 72
- Correlations 169
- CP300 Ionization Detector 20
- CP350 18
- CP355 18
- CRF-300 relay module 20
- current
 - AC Power 31
 - availability 15
 - maximum 15
- Current Draw Calculations 167
- D**
- D350P 19
- D350R 19
- DACT
 - enable 99
 - onboard 99
- data
 - see also detector data and sensitivity 137
- Data Entry
 - via computer keyboard 44
 - via keypad 44
- data values
 - see also detector data and sensitivity 13
- Date setting 85
- Daylight Savings Time 85
- DC power
 - nonresettable 31
 - resettable 31
 - see also auxiliary DC power 31
- Default Programming 175
- Delete Detector 51
- Delete Module 61
- Description
 - control module 76
 - detector label 59
 - monitor module 69
- Detector 14
 - add 50
 - adding description 56
 - delete 51
 - edit 51
 - enable/disable 53
 - screen display 52
 - type 54
 - verification 54
- Detector Annunciator 20
- detector data 137, 152, 153
 - acceptable range 152
 - printout 152
- Detector Programming 50
- device addressing 81
- Digital Communicator 25
- dimensions
 - cabinet 29
- DIRTY1 153
- DIRTY2 153
- Disable 78
- Disable Point
 - Maintenance Level 123
- Downloading 160, 163
- dress panel 18, 21
- drift compensation 13, 153
 - definition 153
- Drill 16, 130
- E**
- earth ground 31
- edit
 - control module 70
 - detector 51
 - detector screens 52
 - module, monitor 61
- EIA-232 40
 - for PC/Printer connection 15
 - see also Printer/PC interface 13
- EIA-485
 - for ACS annunciators 15
 - for LCD-80F 15
- Enable 77
- Enable/Disable
 - control module 71
 - detector 53

Index

- module, monitor 64
- End-of-Line Resistor Assembly 20
- Enter key 47
- Erase History 96
- Error Checking 162
- event codes 109
- exiting
 - programming 45, 46
 - Read Status 45, 46

F

- FACP
 - see also Fire Alarm Control Panel 12
- Features 12
- Fire Alarm Control Panel
 - see also FACP 12
- Format Selection Address 156
- Form-C relay 17, 32, 41

G

- general alarm zone 66
 - see also zone Z00 56
- ground fault 40

H

- H350 19
- H350R 19
- H355 19
- H355R 19
- Hazard Condition 136
- History 96
 - erase 96
 - Maintenance Level 124
 - view events 96
- History file 13

I

- I300
 - see also Isolator Module 20
- Indicators 16
- Installation 27
- intelligent 12
- Inventory 12
- INVREP 153
- Isolator Module 20

K

- Key Panel 16
 - function keys 16
 - service/program keys 16
- keyboard and keypad 44
- Keypad/Display
 - removal and installation 37

L

- lamp test 16
- LCD display 13, 16
- LCD-80F annunciator 14, 24
- LDM Series annunciator 24
- LDM-32 Graphic Annunciator 14
- LED

- AC Power 131
- Alarm Silenced 131

- Battery 131
 - Disabled 131
- Fire Alarm 131
- Ground 131
- Kiss-off 131
- Maintenance 131
- Primary Line Active 131
- Secondary Line Active 131
 - see also Indicators 16
- Supervisory 131
- Trouble 131

- LED annunciator 23
- Local Energy Municipal Box Service 38
- Loop Setup 81

M

- M300 Monitor Module 20
- M301 Miniature Monitor Module 20
- M302 2-wire Monitor Module 20
- main circuit, mounting 27
- Maintenance Alert 13, 137
 - levels 153
- maintenance alert 153
- Maintenance Program Level 2 46, 122
- Manual Dial Mode 116
- Manual programming 45
- Manual Pull Station 20
- Master Program Level 1 46, 48
- MDF-300 monitor module 19
- Medical Alert 136
- MMF-300 monitor module 19
- MMF-300-10 19
- MMF-301 monitor module (miniature) 19
- MMF-302 monitor module 19
- Mode key 47
- Module 13
 - add 60
 - addressing 19
 - delete 61
 - edit monitor 61
 - enable/disable 64
 - see also addressable modules 19
- Module Programming 60
- Monitor module 19
 - adjective 67
 - enable/disable 64
 - noun 68
 - noun/adjective 66
 - type 64
 - type action 65
 - Type list 64
 - type selection 65
- Mounting
 - cabinet 27
 - main circuit board 27
- municipal box transmitter
 - see also 4XTMF module 38

Index

N

NAC 14, 17, 88, 90, 136

Auto Silence 91

coded 138

coding 91

current 14

End-of-Line Resistor 14

power 12

see also Notification Appliance Circuit 12, 32

silence inhibit 93

silenceable 90

Style configuration 33

Style Y wiring diagram 33

synchronized 138

type codes 90

voltage drop 14

voltage, operating 14

wiring Style 32

NAC enable/disable 89

NAC options 82

NACKEY card 33

N-ELR Mounting Plate 20

NFPA 72 Auxiliary Fire Alarm System 176, 177

NFPA 72 Central Station Service (Protected Premises Unit) or Remote Station Service 176

NFPA 72 Proprietary Fire Alarm System 176

NFPA 72 Proprietary Protective Signaling Systems 179

NFPA 72 Remote Station Protective Signaling System 178

NFPA Battery Requirements 168

NFPA Standard 176

nonpower-limited

relay connections 32

Nonresettable Power 17

current 15, 31

nonsilenceable

waterflow 80, 95

Normal 132

normal display 45

Notification Appliance Circuit 14, 88

see also NAC 12, 32

Noun

list 58

monitor module 68

multiple entries 59

Noun/Adjective 56, 58

control module 73

monitor module 66

O

Off-line Programming 45

Operating Instructions 130

Operation

alarm 134

disable/enable 137

hazard condition 136

medical alert 136

NAC 136

normal 132

process monitor 136

programmed zone 137

supervisory 135

trouble 132

waterflow 137

Option Modules 21, 37, 98

annunciators/UDACT 98

Printer/PC 117

Options 12

Output Circuits 17

P

Panel ID 101

Panel Identification Number 162

PAS 55, 78, 139

see also Positive Alarm Sequence 13, 54

selection 66

PAS BYPASS 139

PAS timer 86

Password 13, 46

change 118

Maintenance Level 2 47, 122

Master Level 1 47

PC (personal computer)

configuration 40

connection 40

ground fault 40

Phone Number 107

Piezo

see also sounder 16

PK-CD Programming Utility 21

Point Program 50

Positive Alarm Sequence 54, 139

see also PAS 13

power

NAC 12

nonresettable 15

resettable smoke 15

system 12

power supply calculations 165

power-limited

relay connections 32

Power-up

first time 46

Pre-signal 13, 55, 78

function 138

selection 66

Pre-signal Delay timer 87

Pre-signal timer 86

Primary Phone 100

primary power

see also AC Power 31

printer

baud rate 117

configuration 40

connection 40

ground fault 40

Index

- setup 40
- Printer/PC interface 13
- Process Monitor 136
- Program
 - check 120
 - check correlations 120
 - clear 119
- Program Check
 - Maintenance Level 125
- program keys
 - see also Key Panel 16
- Programming 44, 45
 - autoprogramming 45
 - exiting 45
 - factory default 175
 - Level 1 46
 - Level 2 46
 - manual 45
 - Master Level 1 48
 - modules 60
 - off-line computer 45
 - via computer keyboard 44
 - via panel keypad 44
- Programming Levels 46
- Programming Screens 46
- Programming Sheet 171, 172, 173
- Programming Utility
 - see also PK-CD 21
- PRT/PK-CABLE
 - for PC/Printer connection 40
- R**
- RA400Z
 - see also detector annunciator 20
- Read Status 45, 142
 - annunciators 149, 150
 - exiting 45
 - history 148
 - NAC 147
 - power 145
 - Print 152
 - printer/PC 151
 - program check 148
 - relay 147
 - system point 143
 - Time-Date 154
 - timers 146
 - trouble reminder 146
 - zones 144
- Real-Time Clock 137
- Recall/Increment Function 59, 69, 76
- Receivers 159
- Relay 14, 17, 32, 94
 - connections 32
 - contact rating 14, 17, 32
 - fixed 32
 - Form-C 14, 94
 - programmable 12, 17, 32
 - programming 94
 - selections 94
 - trouble 12, 17, 32
- Relay Control Module
 - see also ACM-8RF 41
- relay module 20
- Relay options 82
- Remote Station Service 38
- remote switch functions 13
- remote sync output 15
- Remote Synchronization 34
- REN
 - see also Ringer Equivalence Number 25
- Report Style 116
- Reporting Enable 103
- Reset 16, 130
- Resettable Power 17, 31
 - current 31
 - see also Smoke Detector Power 15
- Ring Count 103
- Ringer Equivalence Number 25
- S**
- SD300 Photoelectric Detector 20
- SD300T Photoelectric Detector 20
- SD350 18
- SD350T 18
- SD355 18
- SD355T 18
- Secondary Phone 100
- Secondary Power Requirements 168
- Secret Code 161
- Security Features 161
- sensitivity 137, 153
 - see also smoke detector sensitivity 137
- Service Terminal 101, 102
- Signal rate 13
- Signaling Line Circuit
 - see also SLC 14
- Silence Inhibit 13, 93, 140
- Silenceable
 - control module 73
 - NAC 90
 - waterflow 95
- silenceable circuits
 - synchronized signals 90
- Silenceable waterflow 80
- SLC 13, 17
 - current 14
 - reference manual 14
 - resistance 14
 - see also Signaling Line Circuit 12, 14
 - Style 17
 - voltage 14
 - wiring length 14
- SLC Loop Protocol 81
- SLC Style 81
- smoke detector

Index

- chamber reading 152
- data 137, 152
- sensitivity 13, 137
- Smoke Detector Power
 - current 15
- Software Zones 12, 169
- sounder 16
- Specifications 14
- strobe synchronization 13
- Style 12
- Style B 19
- Style D 19
- Style Y 19, 32
 - NAC wiring 33
 - NC configuration 33
- Style Z 19, 32
 - NAC configuration 33
 - wiring 34
- subscreen 46
- Supervisory 135
- supervisory relay
 - configuring for 4XTMF 39
- sync
 - programming 89
 - see also synchronization 93
- sync output 15
 - current 15
 - End-of-Line resistor 15
 - voltage 15
- synchronization 34, 138, 147
 - by manufacturer 93
 - programming 93
 - see also strobe synchronization 13
- synchronized 138
- synchronized signals 138
 - and silenceable circuits 90
- System
 - Maintenance Level 126
- System Point 143
- system power 12
- System Setup 82
- T**
- Telephone Circuitry 25
- Telephone Company
 - Rights and Warnings 26
- telephone line 36
- Terminal 102, 103
- Test Time Interval 106, 107
- Time and Date
 - Maintenance Level 127
- Time setting 84
- Time-Date setting 82, 84
- Time-out 161
- Timers 82
- Transformer Assembly 18
- Transmittal Priorities 158
- Transmitter Module 38
 - see also 4XTMF module 21
- Trouble 132
- trouble display 133
- trouble relay 12
- Trouble Reminder 82, 140, 146
- trouble responses 133
- two stage operation 92
- Type
 - control module 72
 - detector 54
 - monitor module 64
 - NAC 90
- type code
 - control module 72
 - supervision 137
 - verification 13
- U**
- UDACT-F
 - mounting to BRKT-9600 42
- UL power-limited wiring requirements 35
 - see also power-limited and nonpower-limited 32
- Upload/Download 160
- Uploading 164
- V**
- Verification
 - detector 54
- Verify Loops 95
- View Events 96
- voltage
 - measurements 145
 - ranges 145
- W**
- Walktest 13, 54, 73, 97
 - audible 97
 - Maintenance Level 126
 - operation 141
 - selection 66
 - silent 97
- waterflow
 - nonsilenceable 80, 95
 - silenceable 80, 95
- Waterflow Delay timer 86, 87
- Waterflow Retard Timer 140
- Waterflow Silenceable 82
- Wire Requirements 180
- wiring
 - AC Power 31
 - earth ground 31
 - NAC Style Y 33
 - NAC Style Z 34
- wiring control modules
 - see also Style Y or Style Z 19
- wiring modules
 - see also Style B or Style D 19
- wiring Style 12
- X**
- XRM-24

Index

see Transformer

Z

Z00 56, 66

Z97

PAS zone 55

Z98 55

Zone 97 78

Zone 98 78

Zone Assignment 56, 66, 93

control module 73

Zone Setup 77

Maintenance Level 128

zone type 80

list 80

Zone Z97 55

Zone Z98

pre-signal zone 55

Zones 144, 169

see also software zones 12

Zones Disabled 79

Zones Enabled 79

Zones Installed 79

zones per device 56

Notes

Notes

Notes

Limited Warranty

The manufacturer warrants its products to be free from defects in materials and workmanship for eighteen (18) months from the date of manufacture, under normal use and service. Products are date-stamped at time of manufacture. The sole and exclusive obligation of the manufacturer is to repair or replace, at its option, free of charge for parts and labor, any part which is defective in materials or workmanship under normal use and service. For products not under the manufacturer's date-stamp control, the warranty is eighteen (18) months from date of original purchase by the manufacturer's distributor unless the installation instructions or catalog sets forth a shorter period, in which case the shorter period shall apply. This warranty is void if the product is altered, repaired, or serviced by anyone other than the manufacturer or its authorized distributors, or if there is a failure to maintain the products and systems in which they operate in a proper and workable manner. In case of defect, secure a Return Material Authorization form from our customer service department. Return product, transportation prepaid, to the manufacturer.

This writing constitutes the only warranty made by this manufacturer with respect to its products. The manufacturer does not represent that its products will prevent any loss by fire or otherwise, or that its products will in all cases provide the protection for which they are installed or intended. Buyer acknowledges that the manufacturer is not an insurer and assumes no risk for loss or damages or the cost of any inconvenience, transportation, damage, misuse, abuse, accident, or similar incident.

THE MANUFACTURER GIVES NO WARRANTY, EXPRESSED OR IMPLIED, OF MERCHANTABILITY, FITNESS FOR ANY PARTICULAR PURPOSE, OR OTHERWISE WHICH EXTEND BEYOND THE DESCRIPTION ON THE FACE HEREOF. UNDER NO CIRCUMSTANCES SHALL THE MANUFACTURER BE LIABLE FOR ANY LOSS OF OR DAMAGE TO PROPERTY, DIRECT, INCIDENTAL, OR CONSEQUENTIAL, ARISING OUT OF THE USE OF, OR INABILITY TO USE THE MANUFACTURER'S PRODUCTS. FURTHERMORE, THE MANUFACTURER SHALL NOT BE LIABLE FOR ANY PERSONAL INJURY OR DEATH WHICH MAY ARISE IN THE COURSE OF, OR AS A RESULT OF, PERSONAL, COMMERCIAL, OR INDUSTRIAL USE OF ITS PRODUCTS.

This warranty replaces all previous warranties and is the only warranty made by the manufacturer. No increase or alteration, written or verbal, of the obligation of this warranty is authorized.



World Headquarters

One Fire-Lite Place, Northford, CT 06472-1653 USA

203-484-7161 • Fax 203-484-7118

www.firelite.com

ISO 9001
CERTIFIED
ENGINEERING & MANUFACTURING
QUALITY SYSTEMS